

Tragstabrichtung

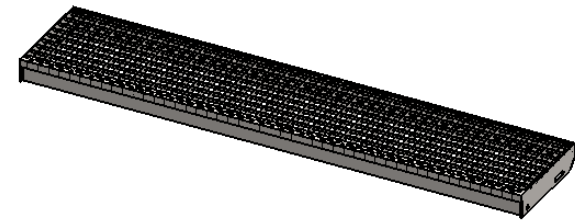
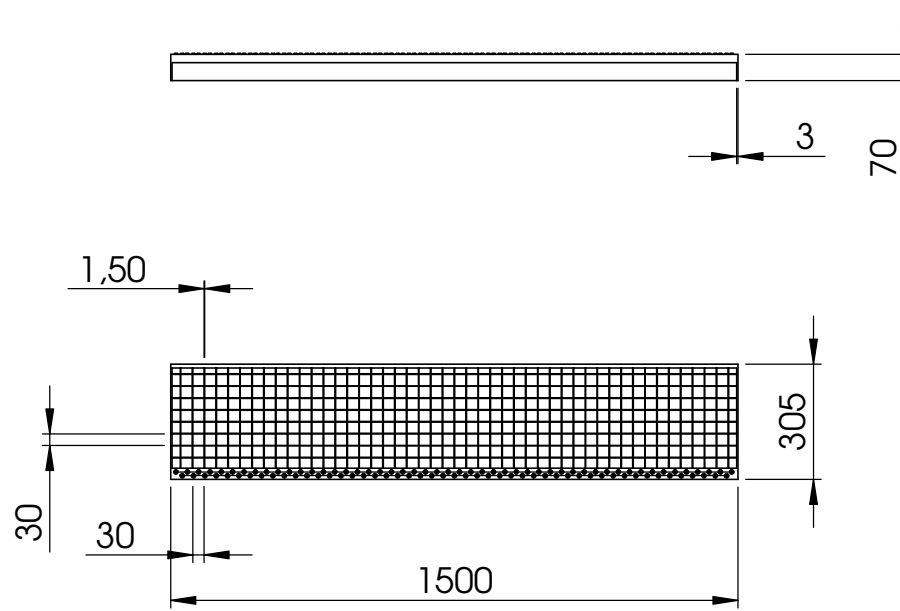

Datum	Artikelnummer	Oberfläche: Feuerverzinkt
04.10.2015	40.1503030.7	
Werkstoff: 1.0037 (S235JR)	Hersteller FeNau GmbH	Blattformat A4
Gewicht 9,940 kg	Maßstab: 1:20	Blatt 1 von 1