

Name	Signatur	Datum	Artikelnummer	Oberfläche: Geschliffen Korn 240
Ch. Höfig	CH	23.07.2019	E 88.11BR.F306M8.V2A	
Werkstoff:				Blattformat
1.4301 (X5CrNi18-10)				A4
Gewicht 0.214 kg		Massstab: 1:1	Version: 1.1	Blatt 1 von 5

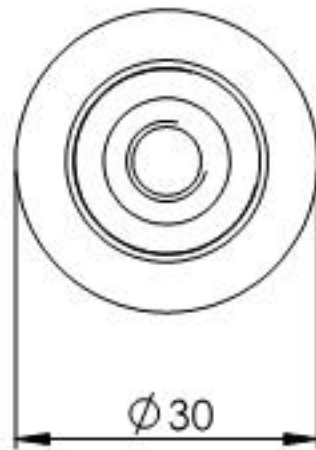

Name	Signatur	Datum	Artikelnummer	Oberfläche: Geschliffen Korn 240
Ch. Höfig	CH	23.07.2019	E 88.11BR.F306M8.V2A	
Werkstoff:				Blattformat
1.4301 (X5CrNi18-10)				A4
Gewicht 0.053 kg		Massstab: 1:1	Version: 1	Blatt 2 von 5

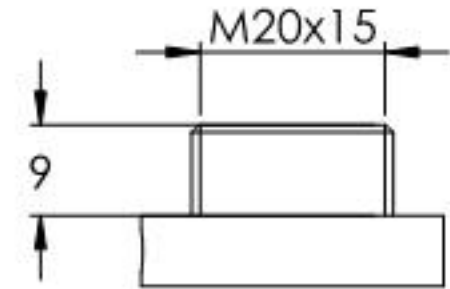
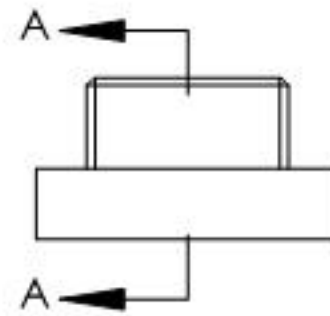
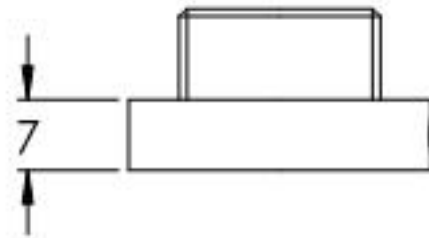
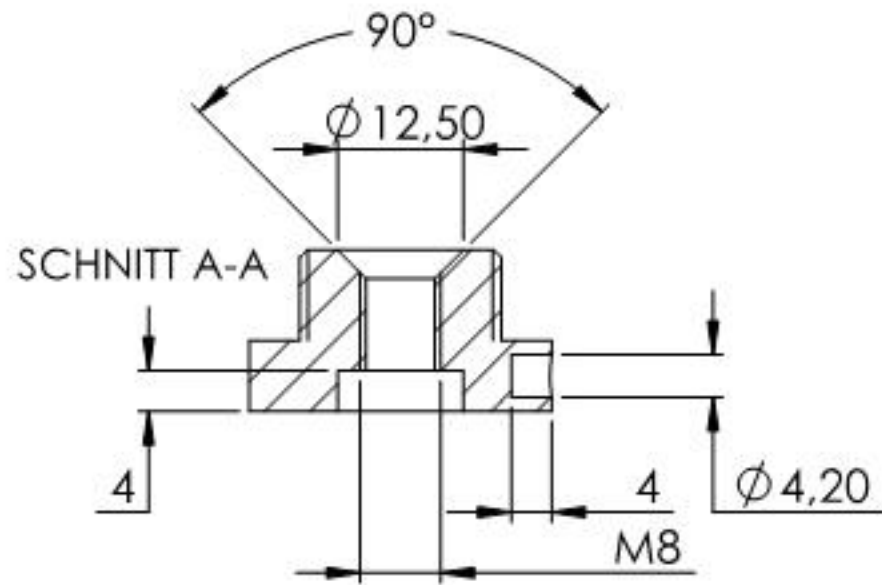
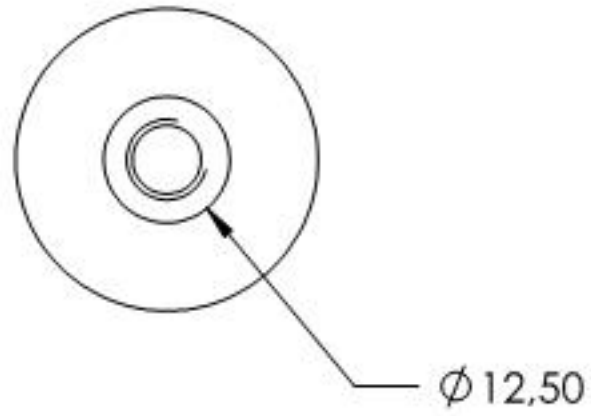
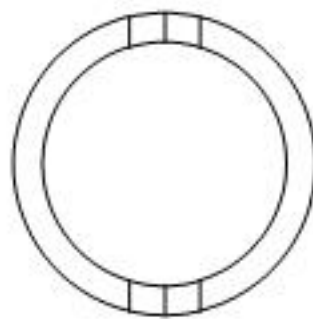
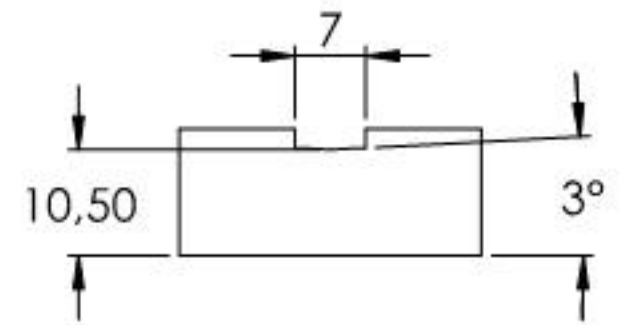
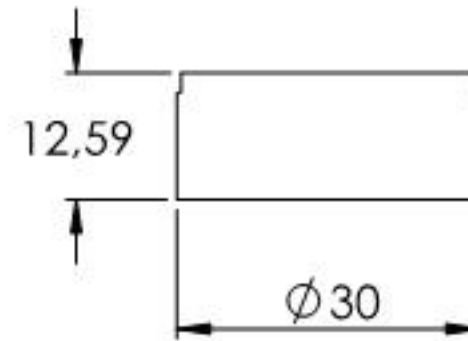
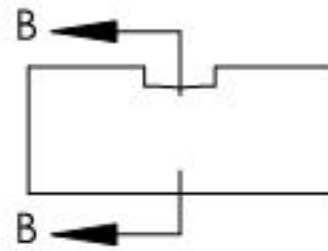
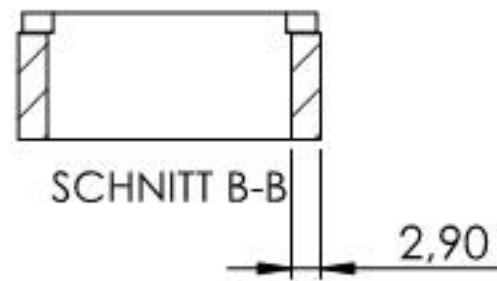
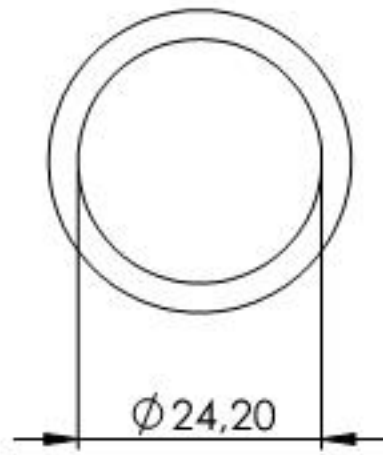

Name	Signatur	Datum	Artikelnummer	Oberfläche: Geschliffen Korn 240
Ch. Höfig	CH	23.07.2019	E 88.11BR.F306M8.V2A	
Werkstoff:				Blattformat
1.4301 (X5CrNi18-10)				A4
Gewicht 0.024 kg		Maßstab: 1:1	Version: 1.1	Blatt 3 von 5