

Name	Signatur	Datum	Artikelnummer	Oberfläche: Geschliffen Korn 240
Ch. Höfig	CH	02.03.2022	88.11123.M24.VA	
Werkstoff:				Blattformat
1.4301 (X5CrNi18-10)				A4
Gewicht 1,494 kg		Maßstab: 1:2	Version: 1	Blatt 1 von 6

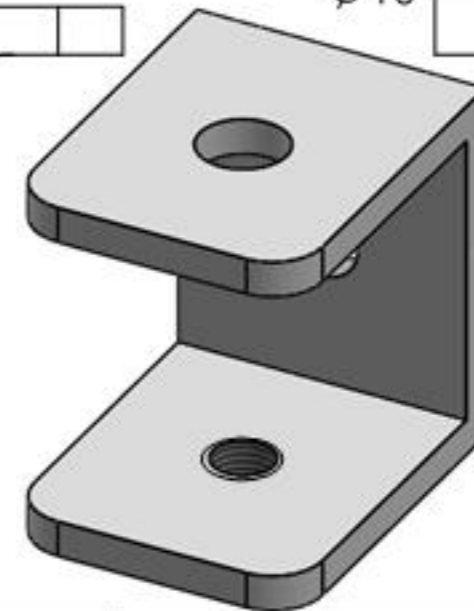

Name	Signatur	Datum	Artikelnummer	Oberfläche: Geschliffen Korn 240
Ch. Höfig	CH	02.03.2022	88.11123.M24.VA	
Werkstoff:				Blattformat
1.4301 (X5CrNi18-10)				A4
Gewicht 0.376 kg		Massstab: 1:1.25 Version: 1		Blatt 2 von 6

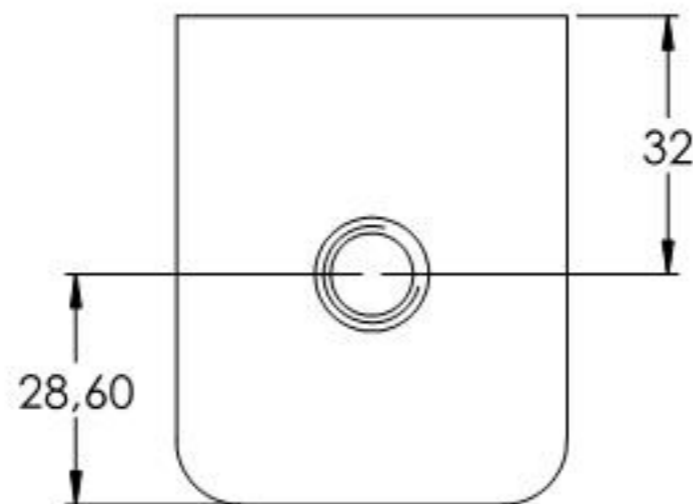
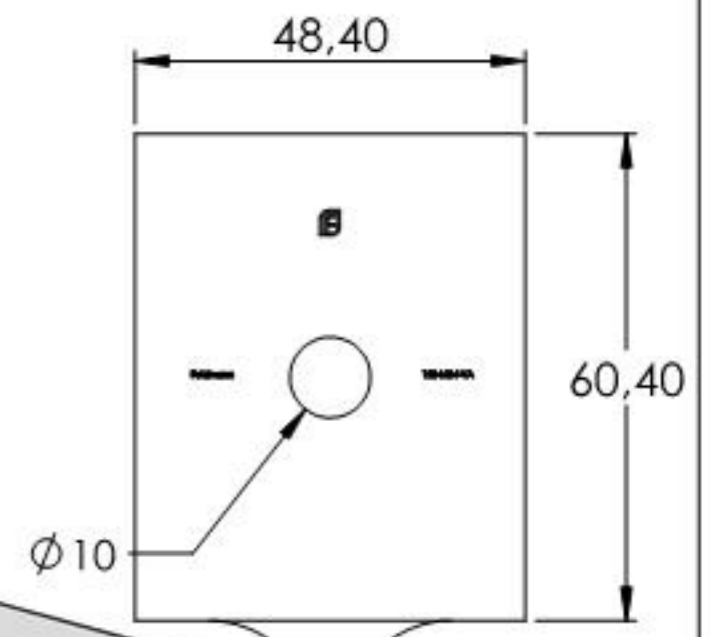
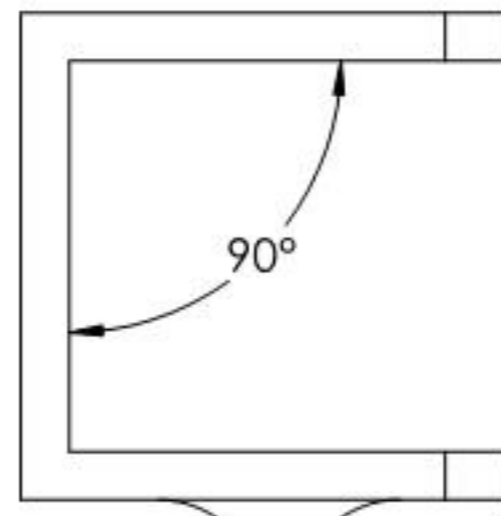
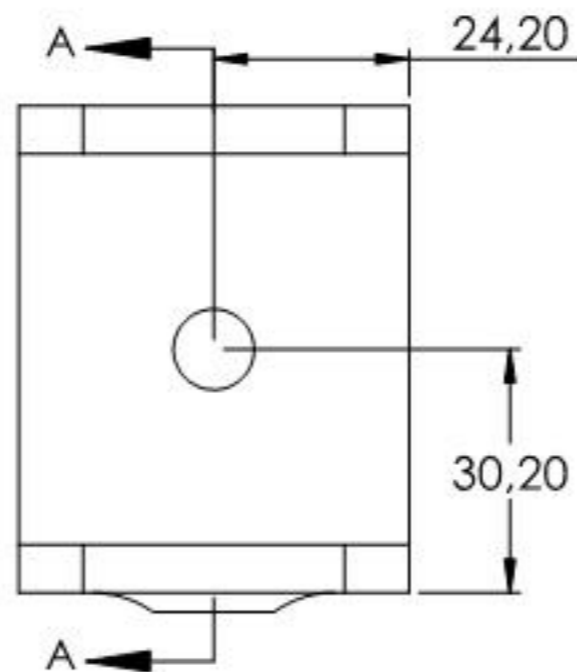
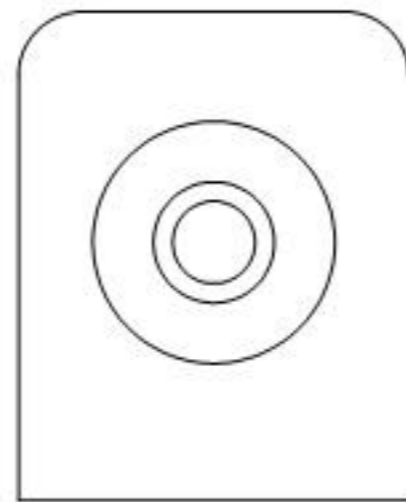
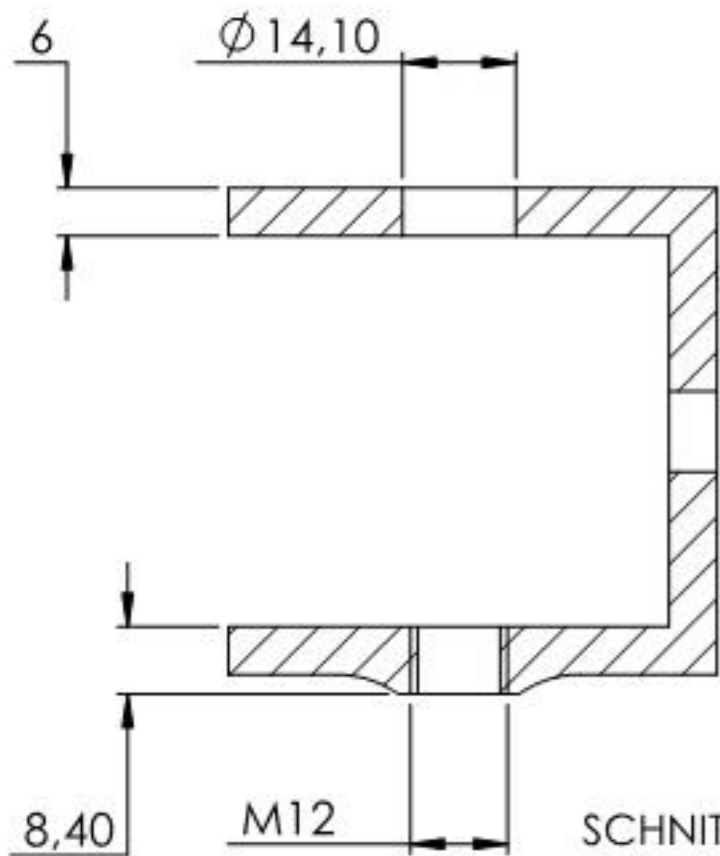
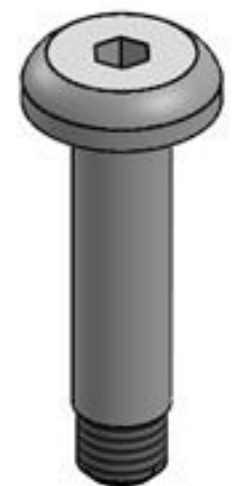
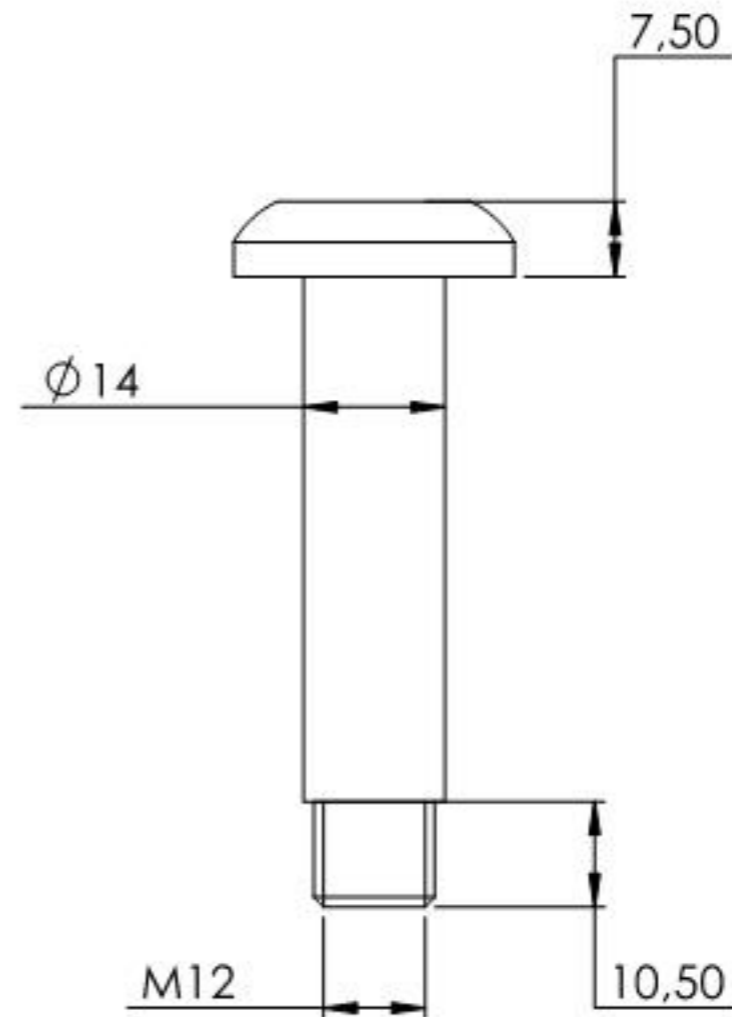
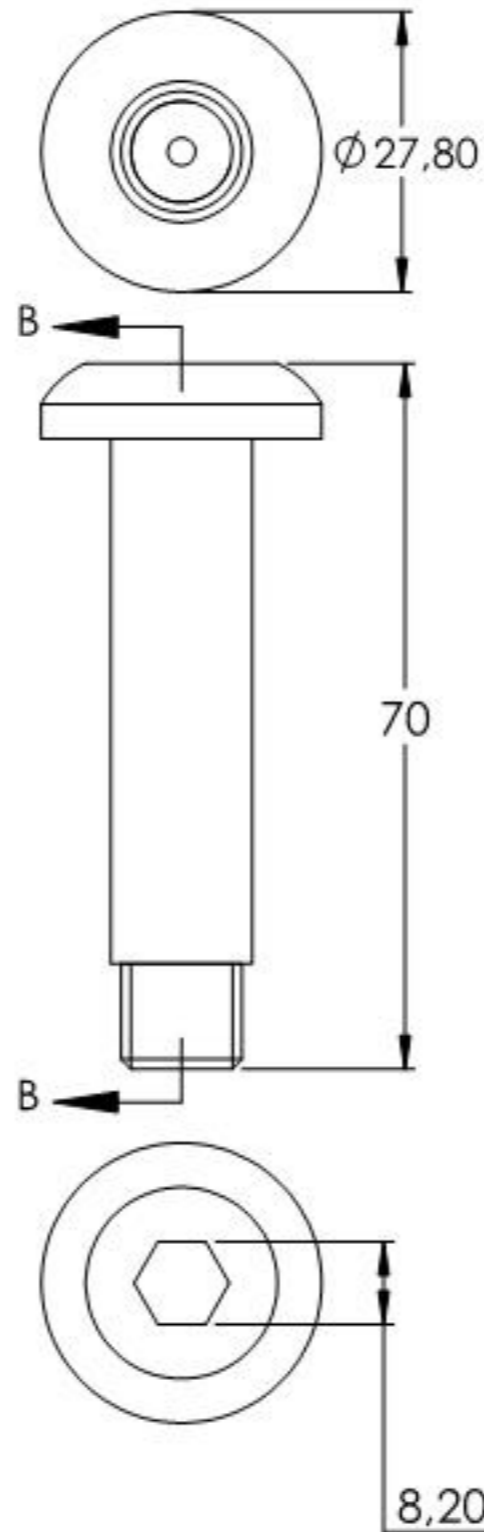
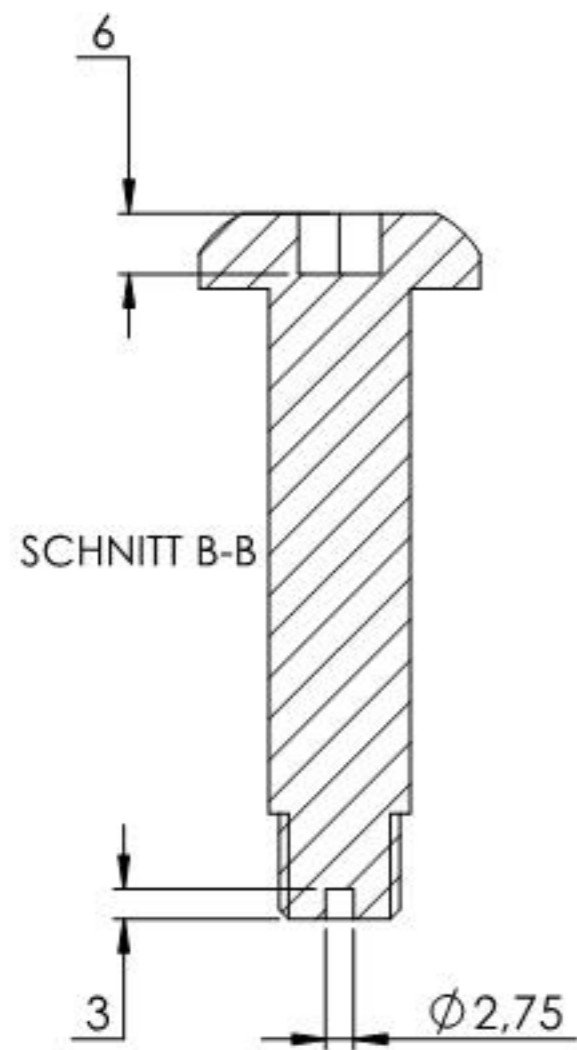

Name	Signatur	Datum	Artikelnummer	Oberfläche: Geschliffen Korn 240
Ch. Höfig	CH	02.03.2022	88.11123.M24.VA	
Werkstoff:				Blattformat
1.4301 (X5CrNi18-10)				A4
Gewicht 0,101 kg	Maßstab: 1:1	Version: 1	Blatt 3 von 6	