

Name	Signatur	Datum	Artikelnummer	Oberfläche: Roh
Ch. Höfig	CH	20.09.2016	<b>30.3250.8</b>	
Werkstoff:				Blattformat
1.0037 (S235JR)				<b>A4</b>
Gewicht 0,819 kg		Maßstab: 1:2,5	Blatt 1 von 5	

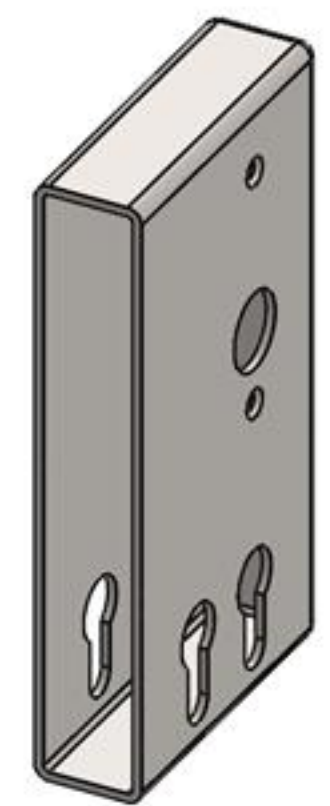

Name	Signatur	Datum	Artikelnummer	Oberfläche: Roh
Ch. Höfig	CH	20.09.2016	<b>30.3250.81</b>	
Werkstoff:				Blattformat
1.0037 (S235JR)				<b>A4</b>
Gewicht 0.737 kg		Maßstab: 1:2.5	Blatt 2 von 5	

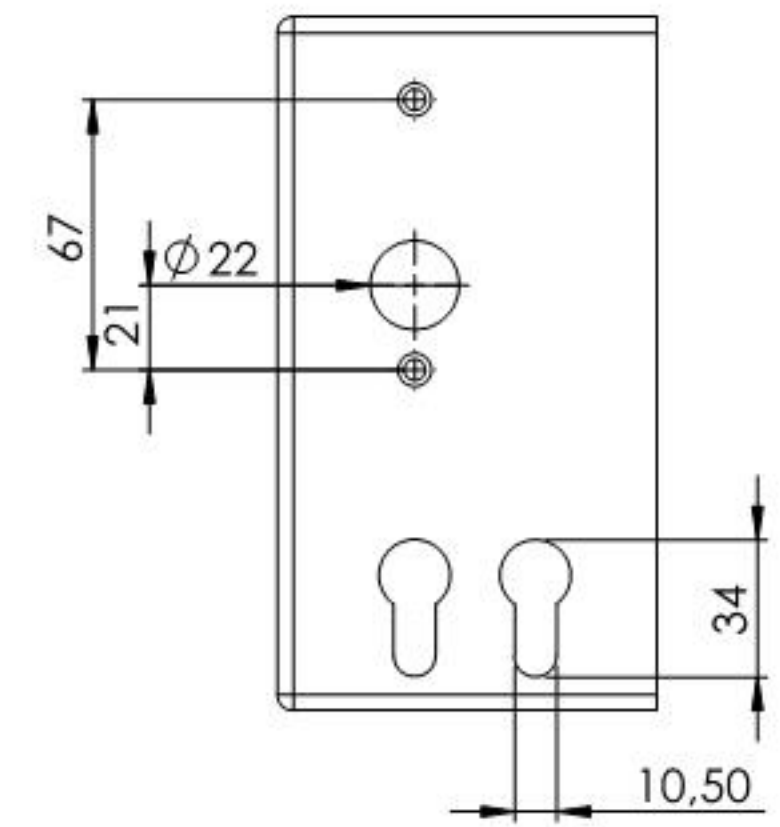
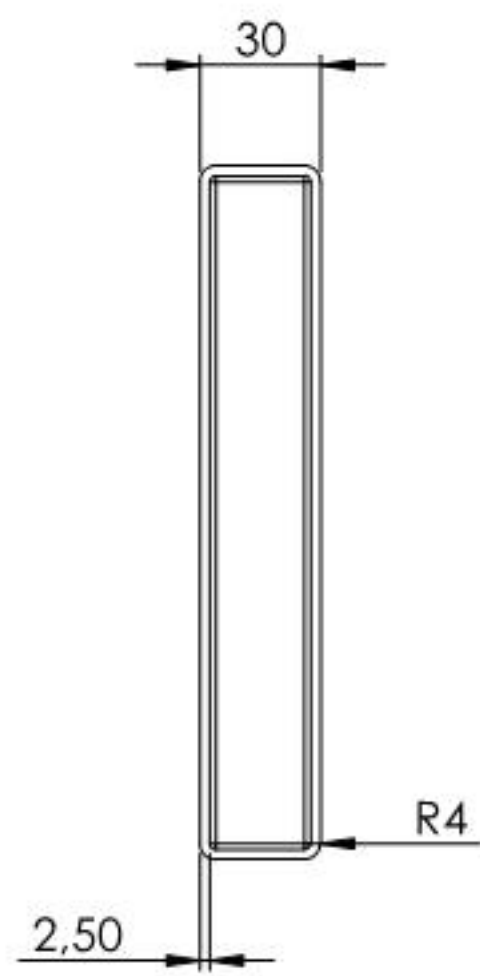
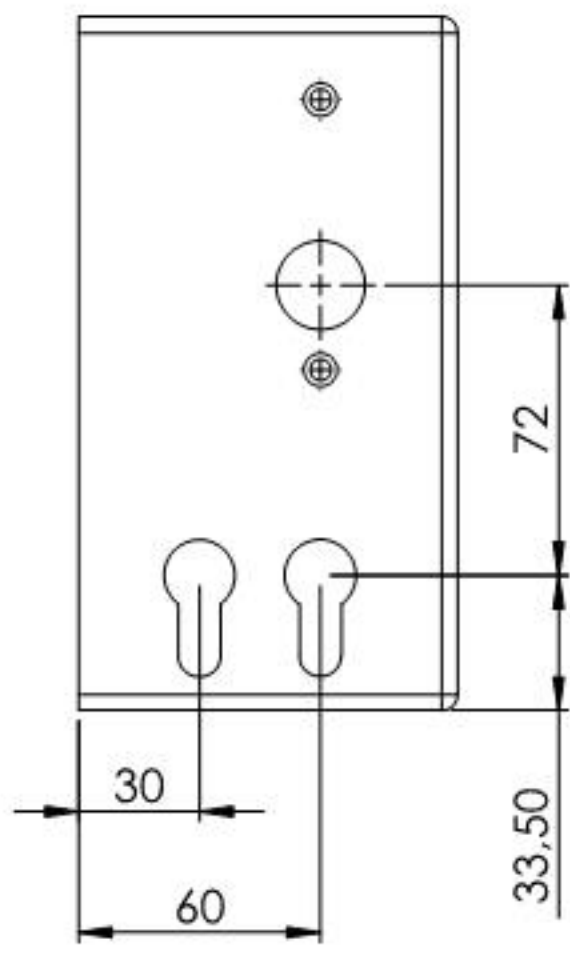
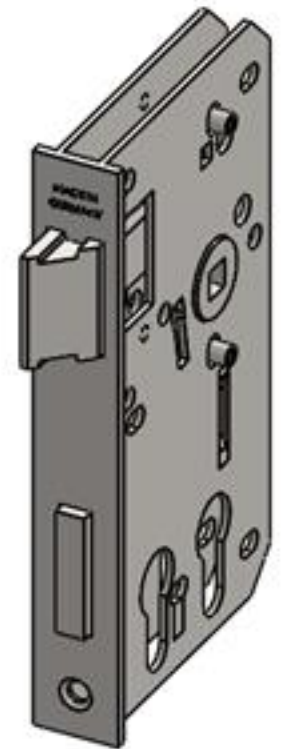
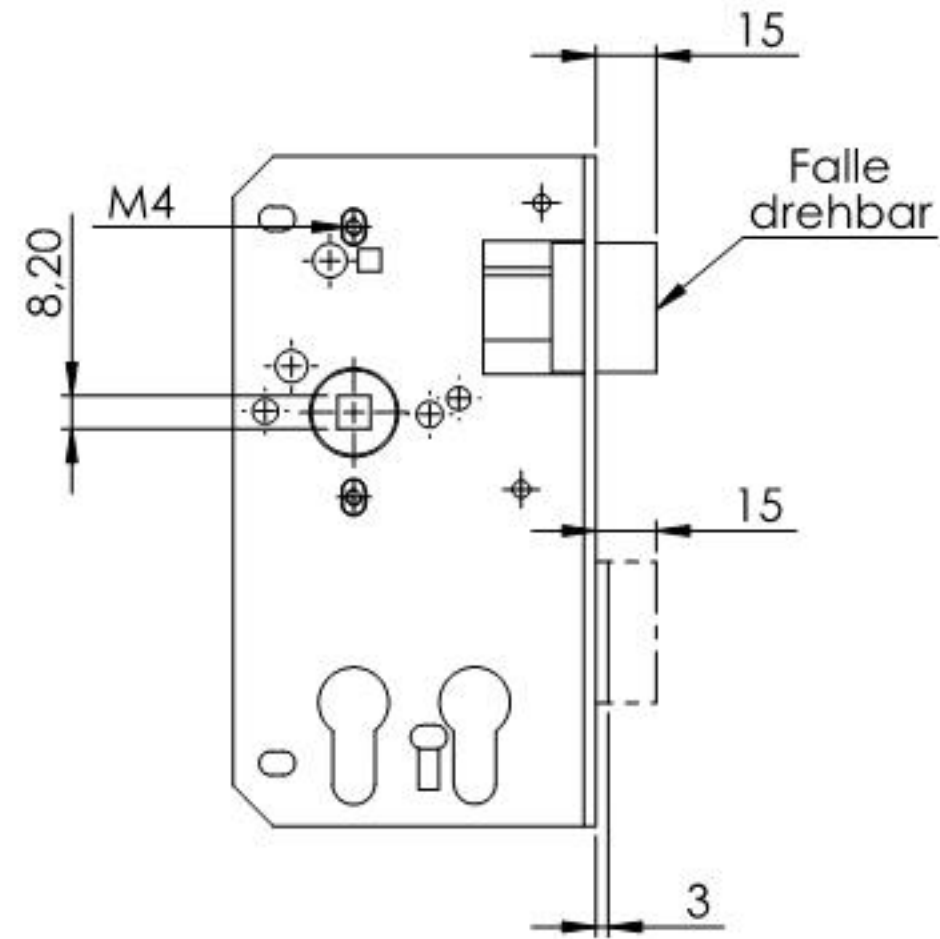
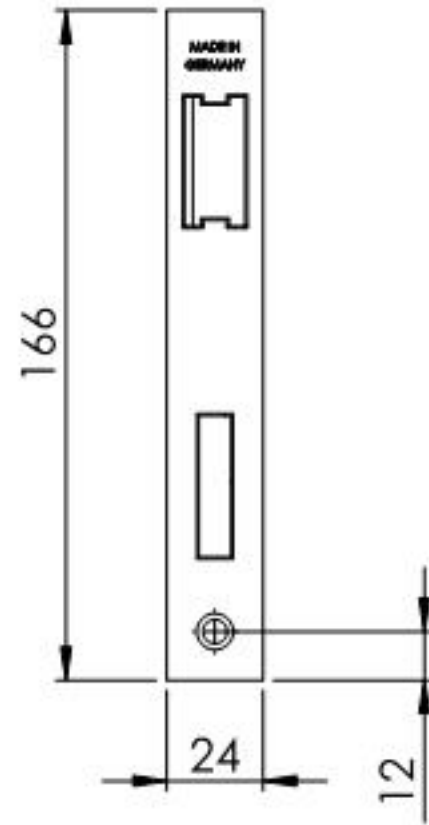
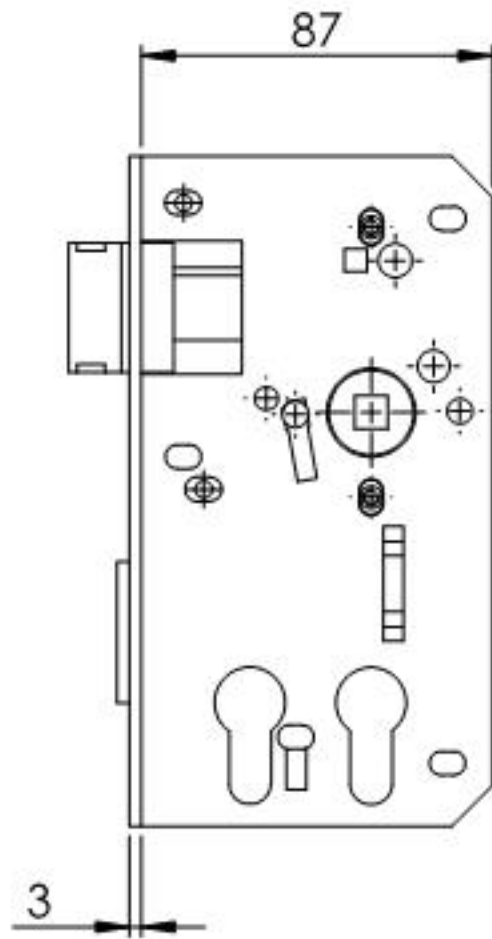

Name	Signatur	Datum	Artikelnummer	Oberfläche: Roh
Ch. Höfig	CH	20.09.2016	<b>30.3250.82</b>	
Werkstoff:				Blattformat
1.0037 (S235JR)				<b>A4</b>
Gewicht 0.079 kg		Maßstab: 1:2.5	Blatt 3 von 5	