

12.2315.4

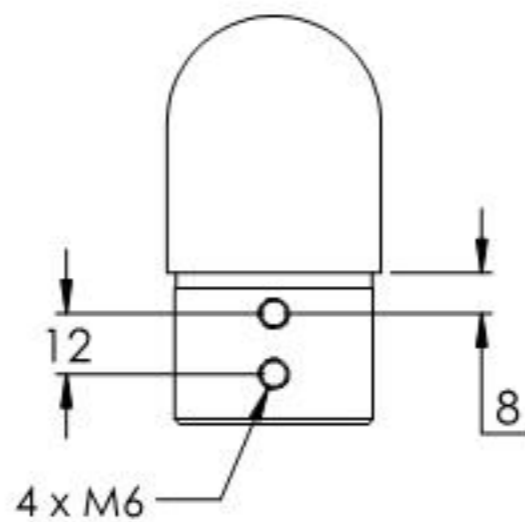

Name	Signatur	Datum	Artikelnummer	Oberfläche: Geschliffen Korn 240
Ch. Höfig	CH	22.10.2019	60320-240	
Werkstoff: 1.4301 (X5CrNi18-10)			Hersteller	Blattformat
			 Feldmann EDLSTAHL-ALUMINIUM-SCHWEIßSTEIN	A4
Gewicht 0.348 kg		Maßstab: 1:2	Version: 1	Blatt 1 von 1