

POS-NR.	BENENNUNG	MENGE
1	50125-240 Teil1	1
2	DIN 913 M8x40	1

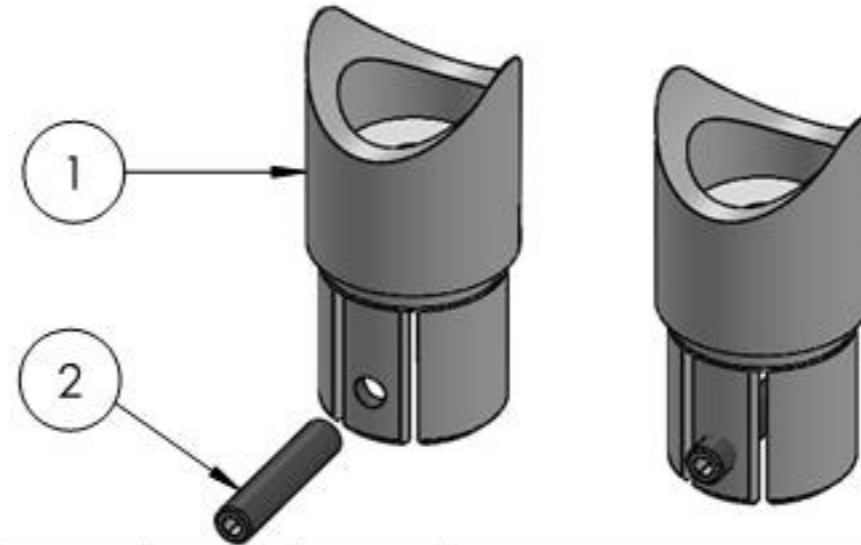
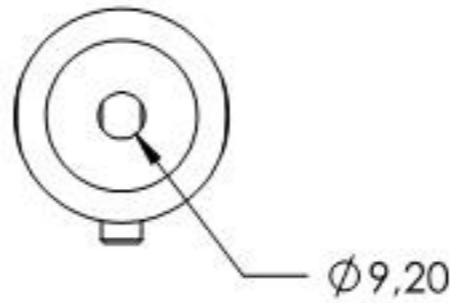
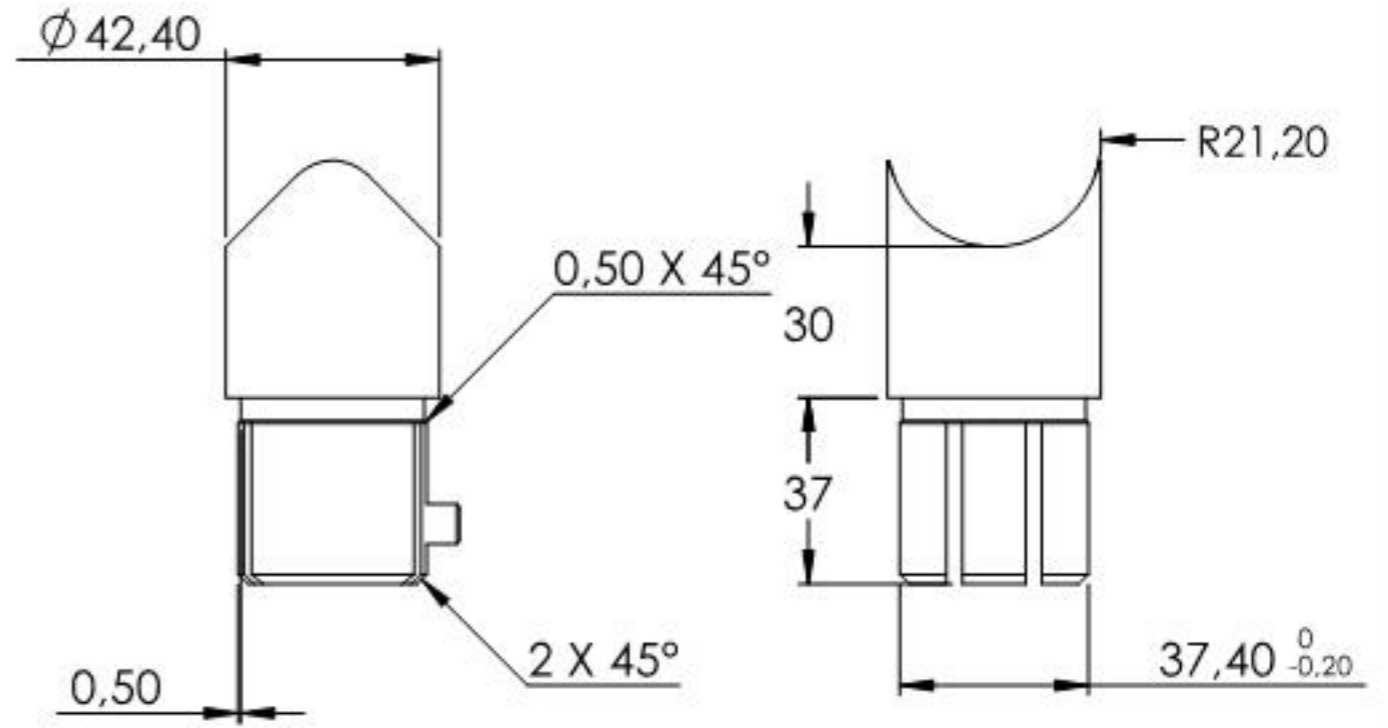
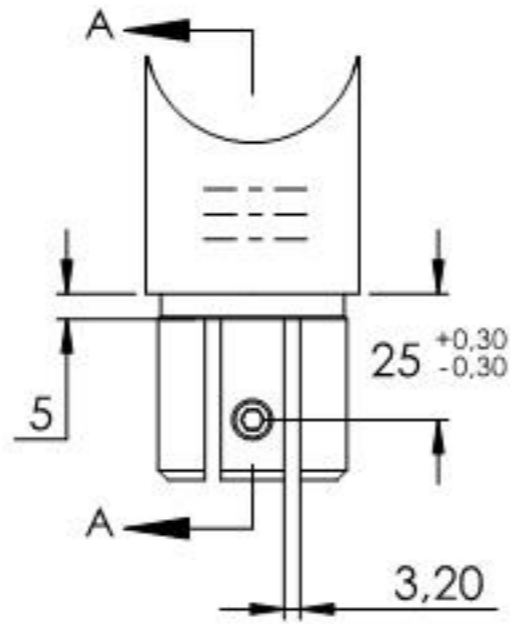
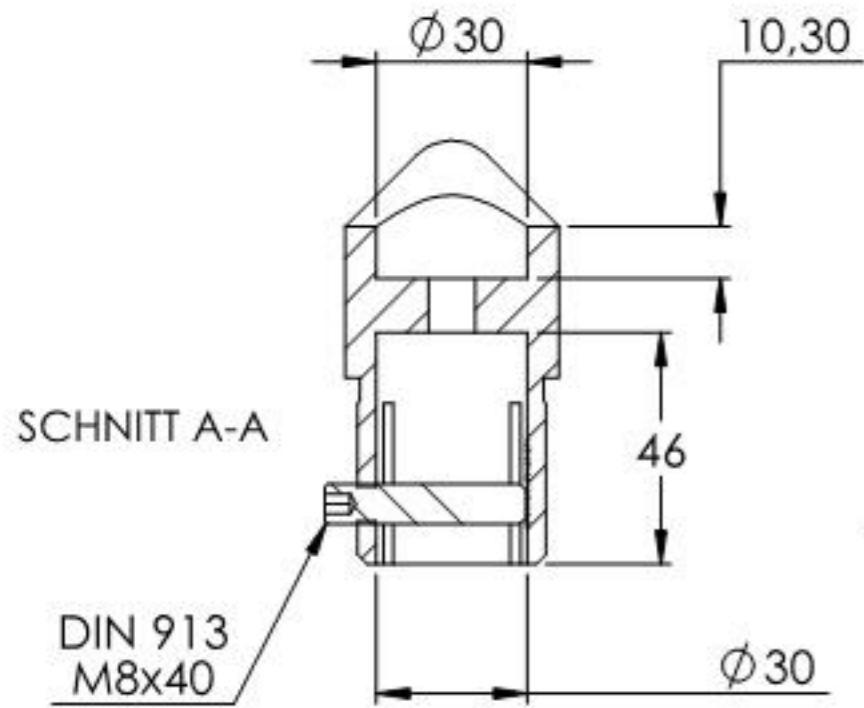
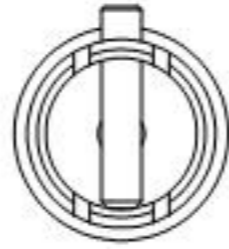

Name	Signatur	Datum	Artikelnummer	Oberfläche: Geschliffen Korn 240
Ch. Höfig	CH	12.06.2019	511.3669.4	
Werkstoff:				Blattformat
1.4301 (X5CrNi18-10)				A4
Gewicht 0.360 kg		Maßstab: 1:2	Version: 1.1	Blatt 1 von 1