

POS-NR.	BENENNUNG	MENGE
1	50123-240 Teil1	1
2	DIN 913 M8x25	1

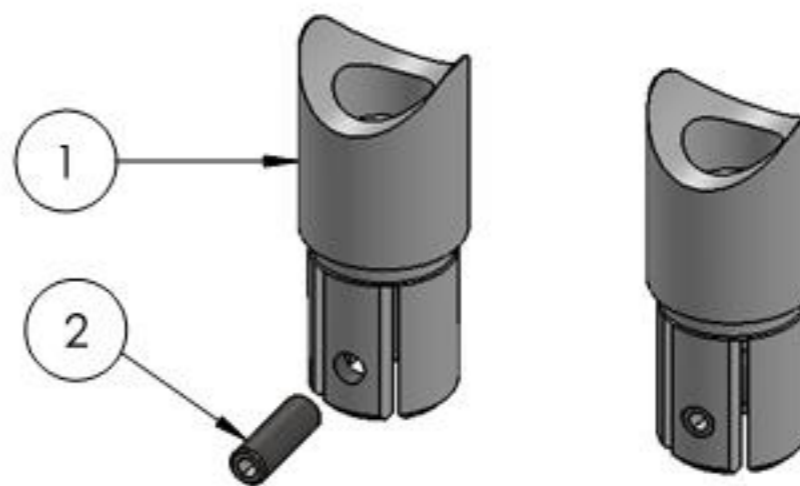
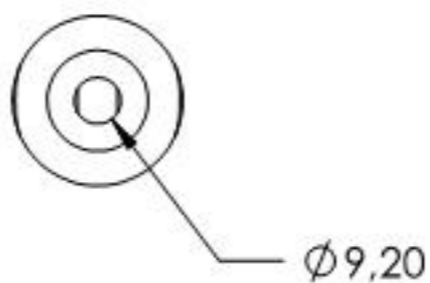
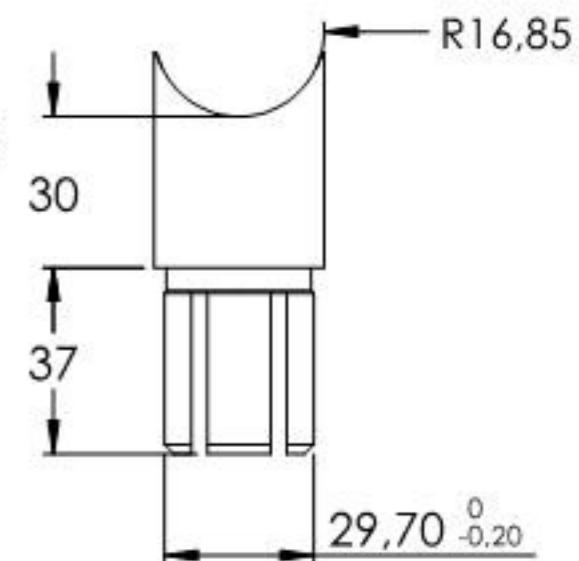
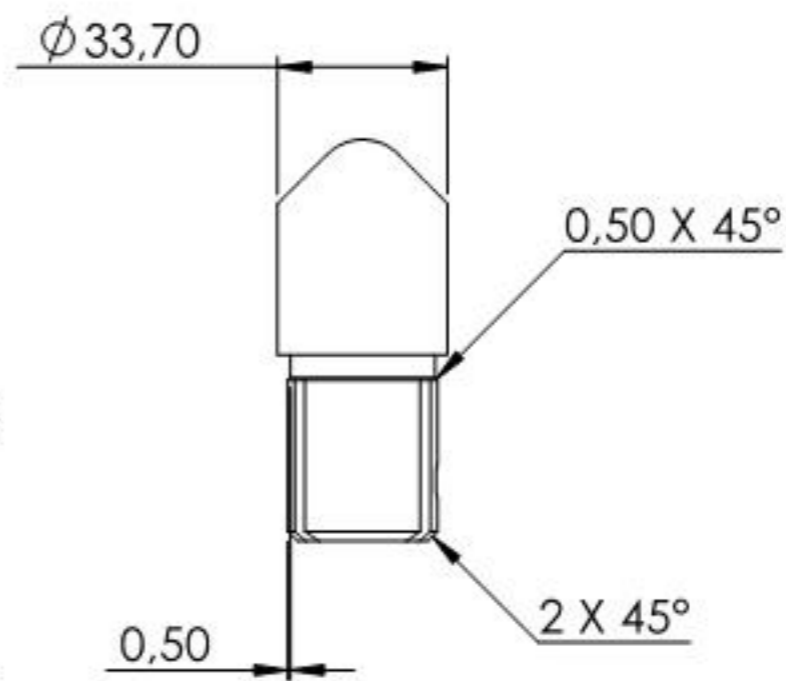
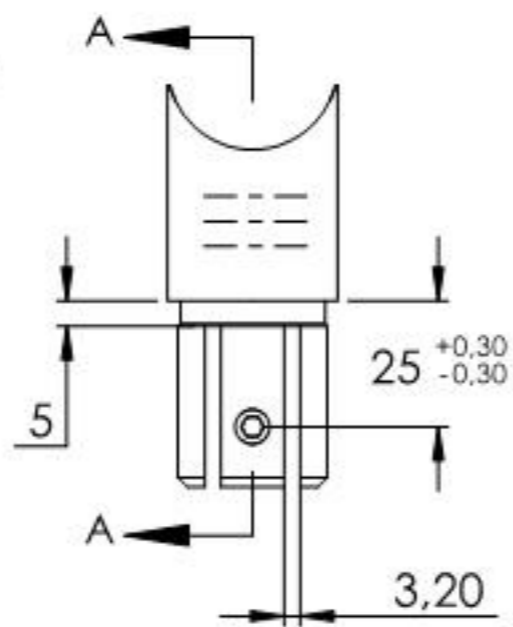
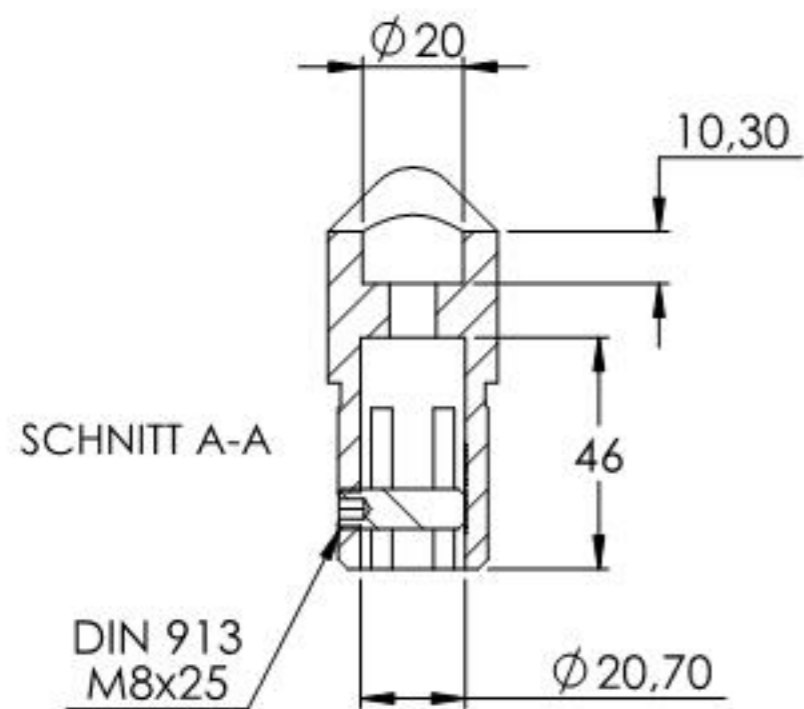

Name	Signatur	Datum	Artikelnummer	Oberfläche: Geschliffen Korn 240
Ch. Höfig	CH	16.07.2019	<b>11.3387.4-STÜCK</b>	
Werkstoff:				Blattformat
1.4301 (X5CrNi18-10)				A4
Gewicht 0.262 kg		Maßstab: 1:2	Version: 1.2	Blatt 1 von 1