

Name	Signatur	Datum	Artikelnummer	Oberfläche: Geschliffen Korn 240
Ch. Höfig	CH	03.11.2023	1 11.2900.4	
Werkstoff: 1.4301 [X5CrNi18-10]				Blattformat A4
Gewicht: 0.120 kg		Maßstab: 1:2	Version: 1	Deutsch
Blatt 1 von 10				

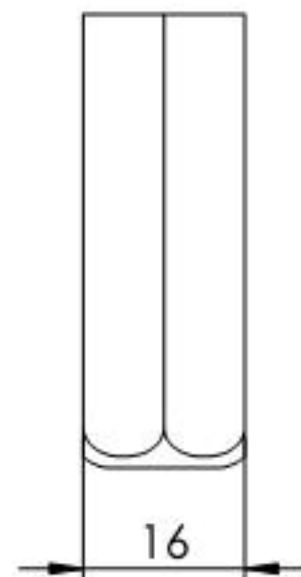

Name	Signatur	Datum	Artikelnummer	Oberfläche: Geschliffen Korn 240
Ch. Höfig	CH	03.11.2023	1 11.2900.4	
Werkstoff:				Blattformat
1.4301 [X5CrNi18-10]				A4
Gewicht: 0.046 kg		Maßstab: 1:1	Version: 1	Deutsch
Blatt 2 von 10				

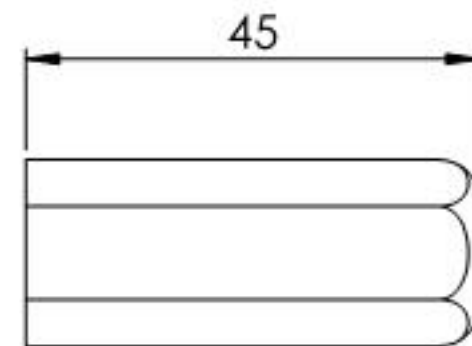
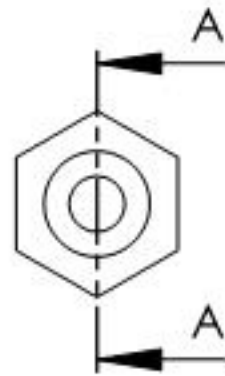
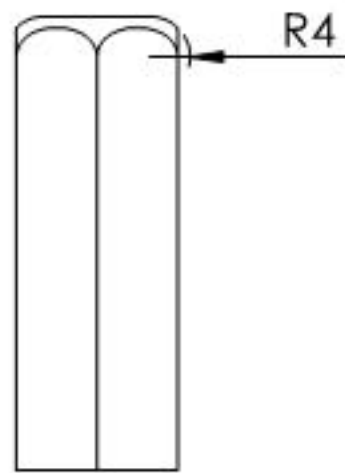
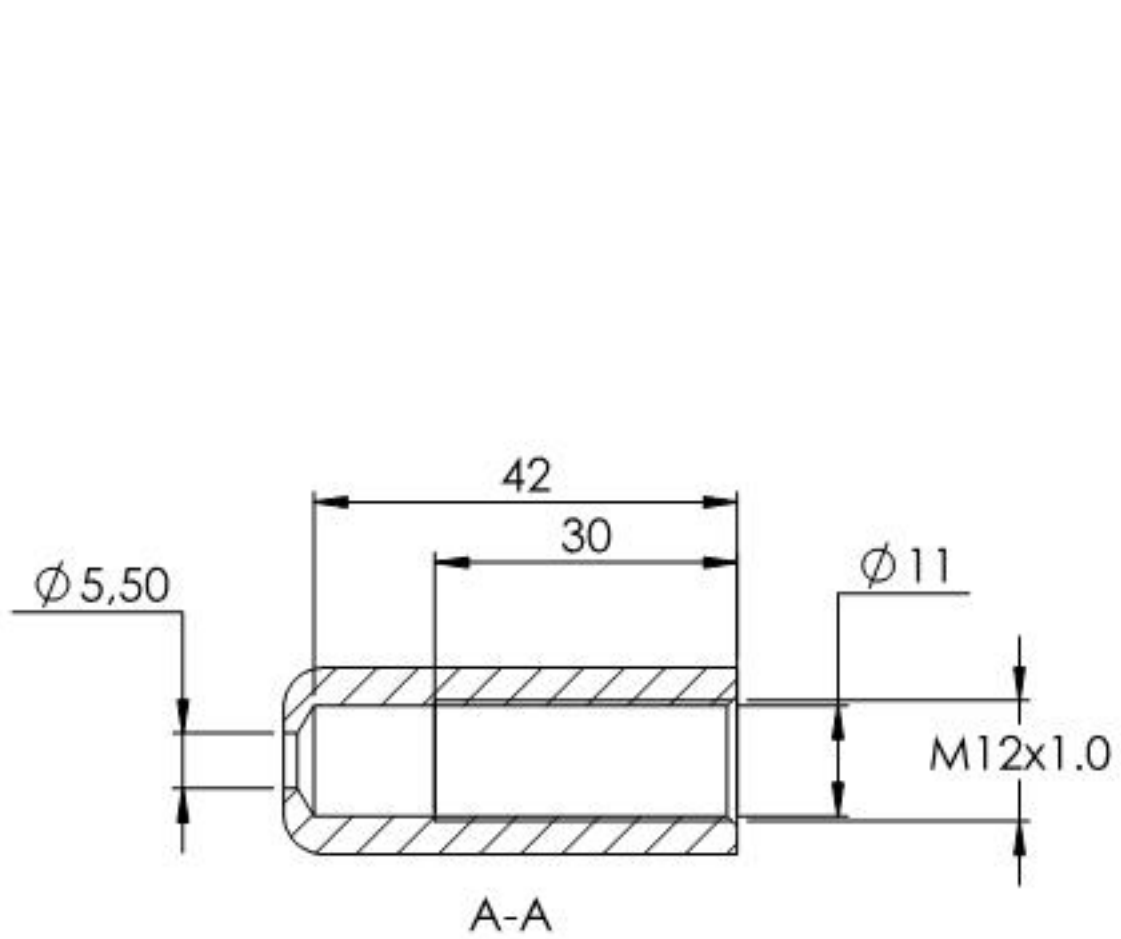
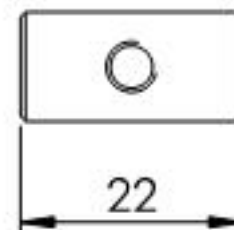
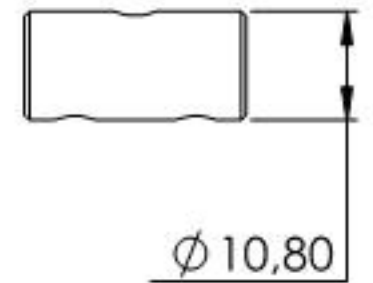
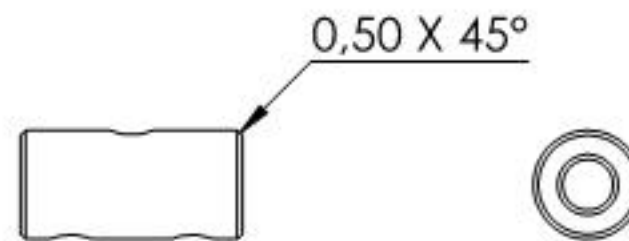
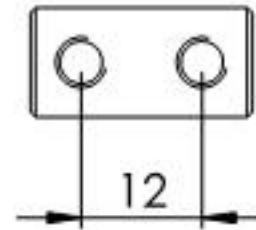
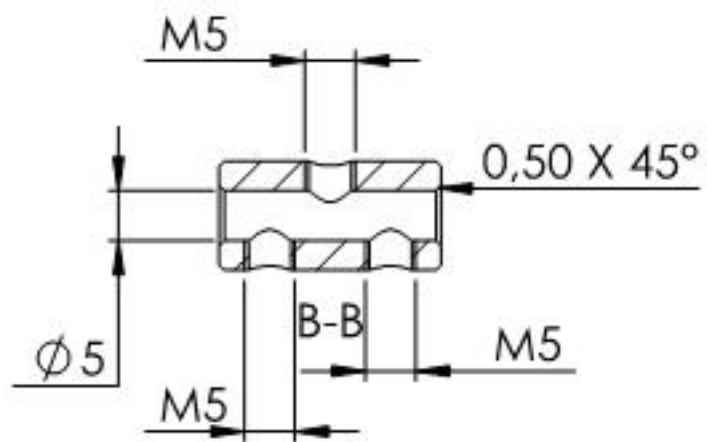

Name	Signatur	Datum	Artikelnummer	Oberfläche: Roh
Ch. Höfig	CH	03.11.2023	1 11.2900.4	
Werkstoff:				Blattformat
1.4301 [X5CrNi18-10]				A4
Gewicht: 0.011 kg		Maßstab: 1:1	Version: 1	Deutsch
Blatt 3 von 10				