

SCHNITT A-A

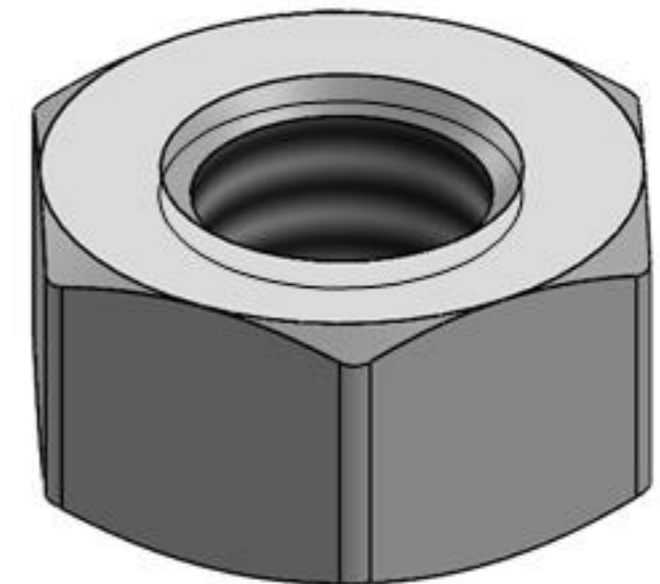
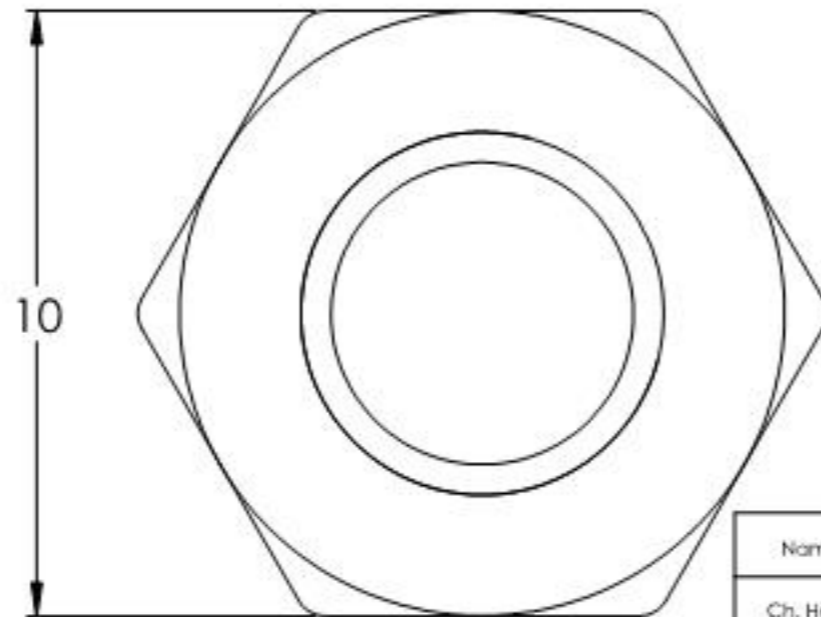
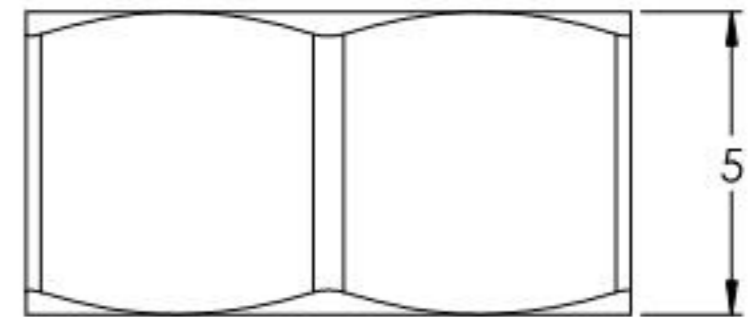
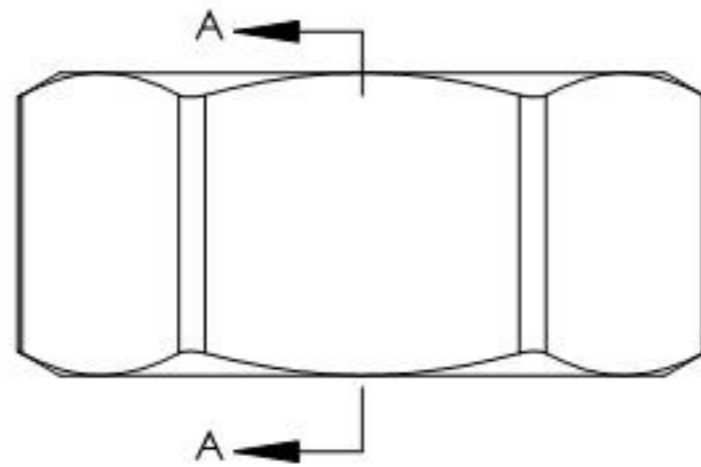

Name	Signatur	Datum	Artikelnummer	Oberfläche: Roh
Ch. Höfig	CH	19.12.2019	ξ11.2862.4	
Werkstoff:				Blattformat
1.4301 (X5CrNi18-10)				A4
Gewicht 0.003 kg		Massstab: 6:1	Version: 1	Blatt 1 von 1