

11.2551.4

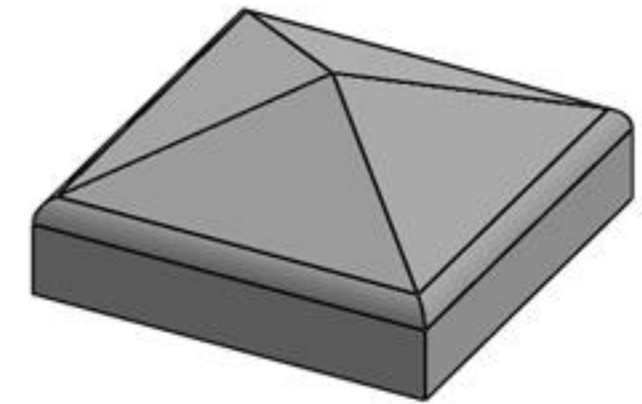
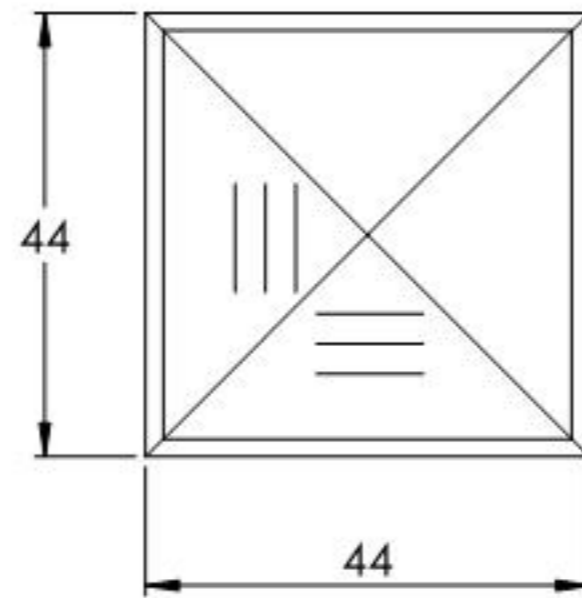
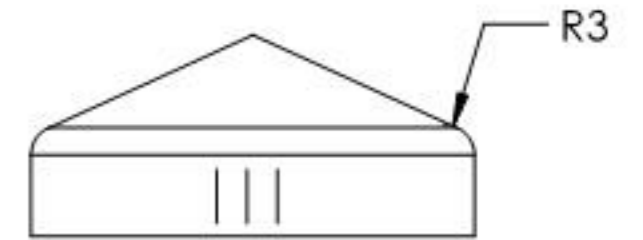
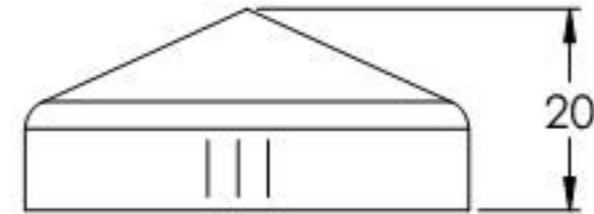
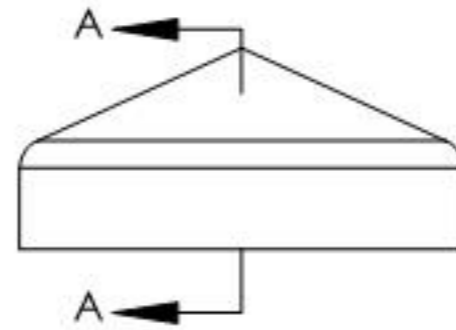
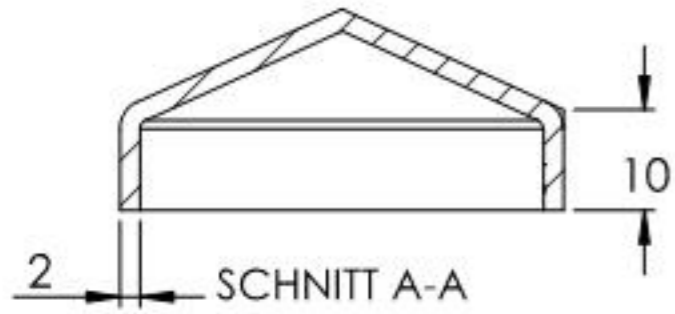
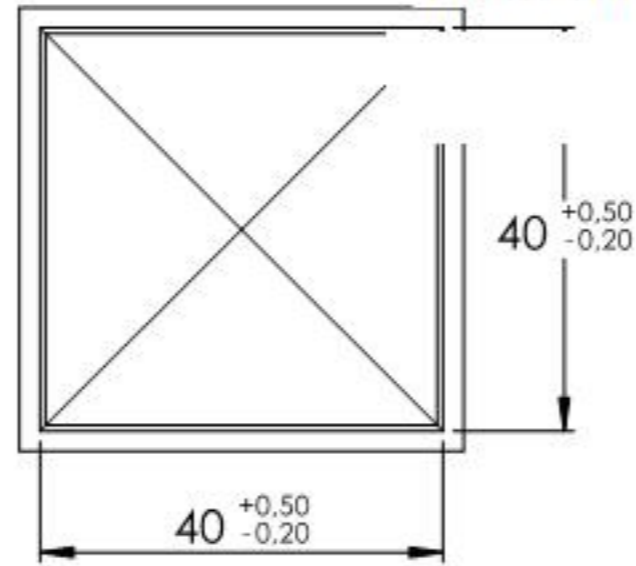

Name	Signatur	Datum	Artikelnummer	Oberfläche: Geschliffen Korn 240
Ch. Höfig	CH	18.09.2019	165-40V2AG	
Werkstoff:		Hersteller		Blattformat
1.4301 (X5CrNi18-10)		 <small>EDLSTAHL-ALUMINIUM-SCHWEIßSTEIN</small>		A4
Gewicht 0.055 kg		Maßstab: 1:1	Version: 1	Blatt 1 von 1