

SCHNITT A-A

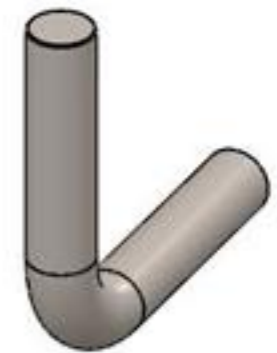
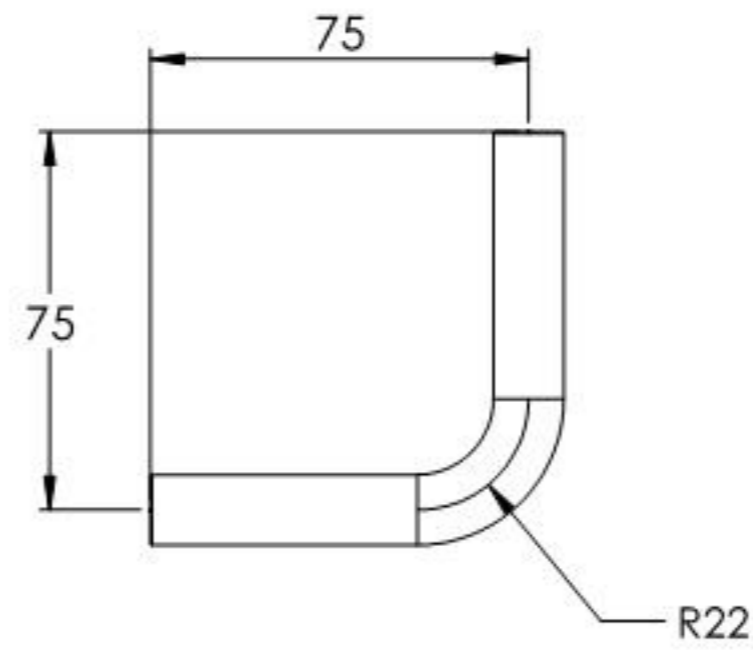
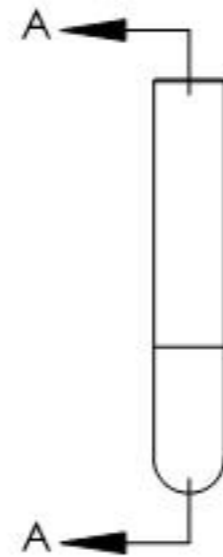

Name	Signatur	Datum	Artikelnummer	Oberfläche: Geschliffen Korn 240
Ch. Höfig	CH	23.09.2020	11.2346.40G	
Werkstoff:				Blattformat
1.4301 (X5CrNi18-10)				A4
Gewicht 0,171 kg		Maßstab: 1:2	Version: 1	Blatt 1 von 1