

11.2062.4

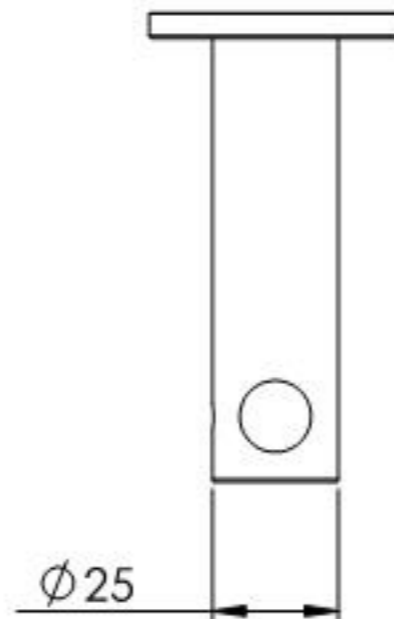

Name	Signatur	Datum	Artikelnummer	Oberfläche: Geschliffen Korn 240
Ch. Höfig	CH	14.12.2020	50352-240 Teil1	
Werkstoff:		Hersteller		Blattformat
1.4301 (X5CrNi18-10)		 Feldmann <small>EDLSTAHL-ALUMINIUM-SCHWEIßSTEIN</small>		A4
Gewicht 0.375 kg		Maßstab: 1:2	Version: 1	Blatt 2 von 8

11.2062.4

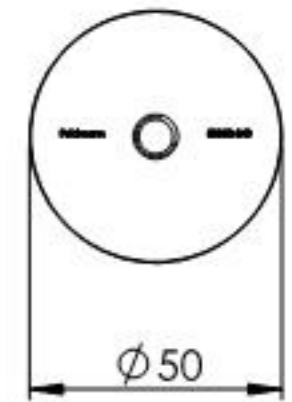
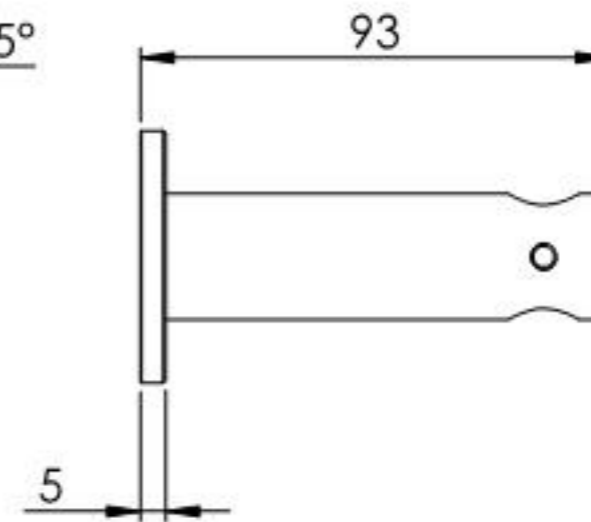
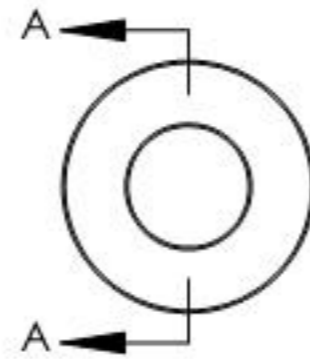
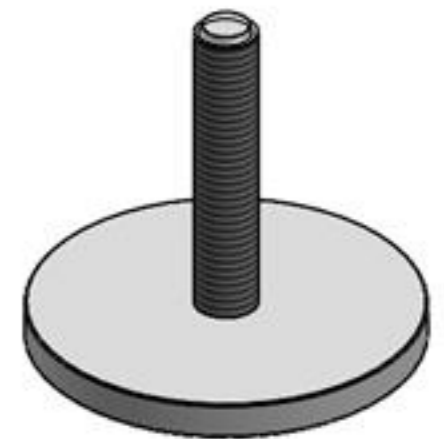
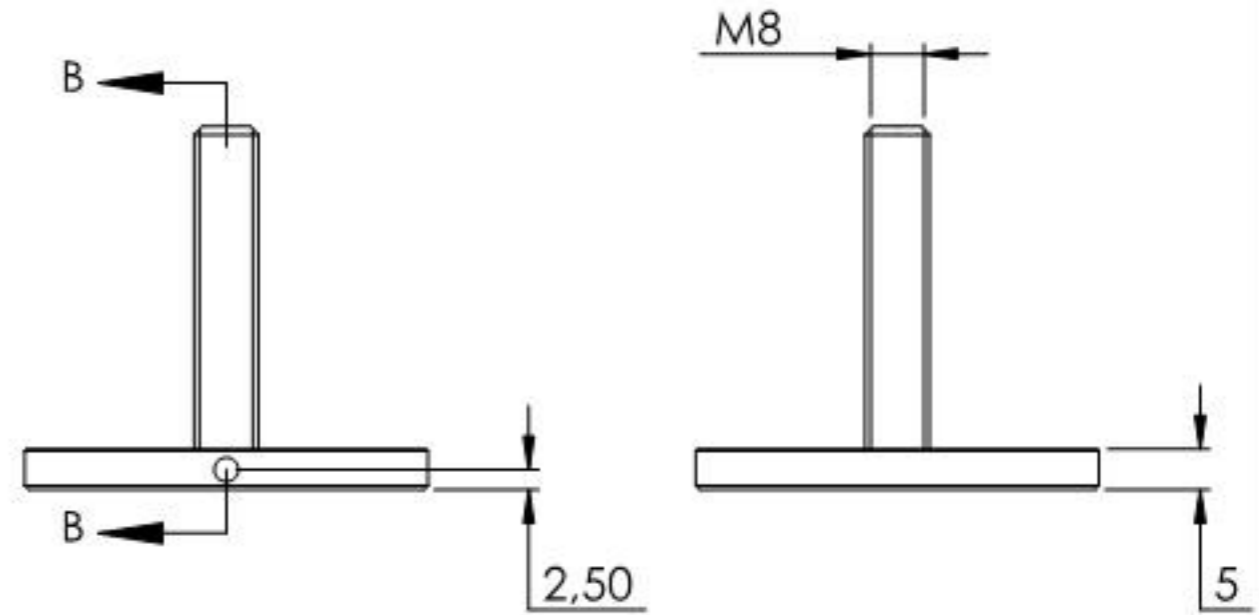
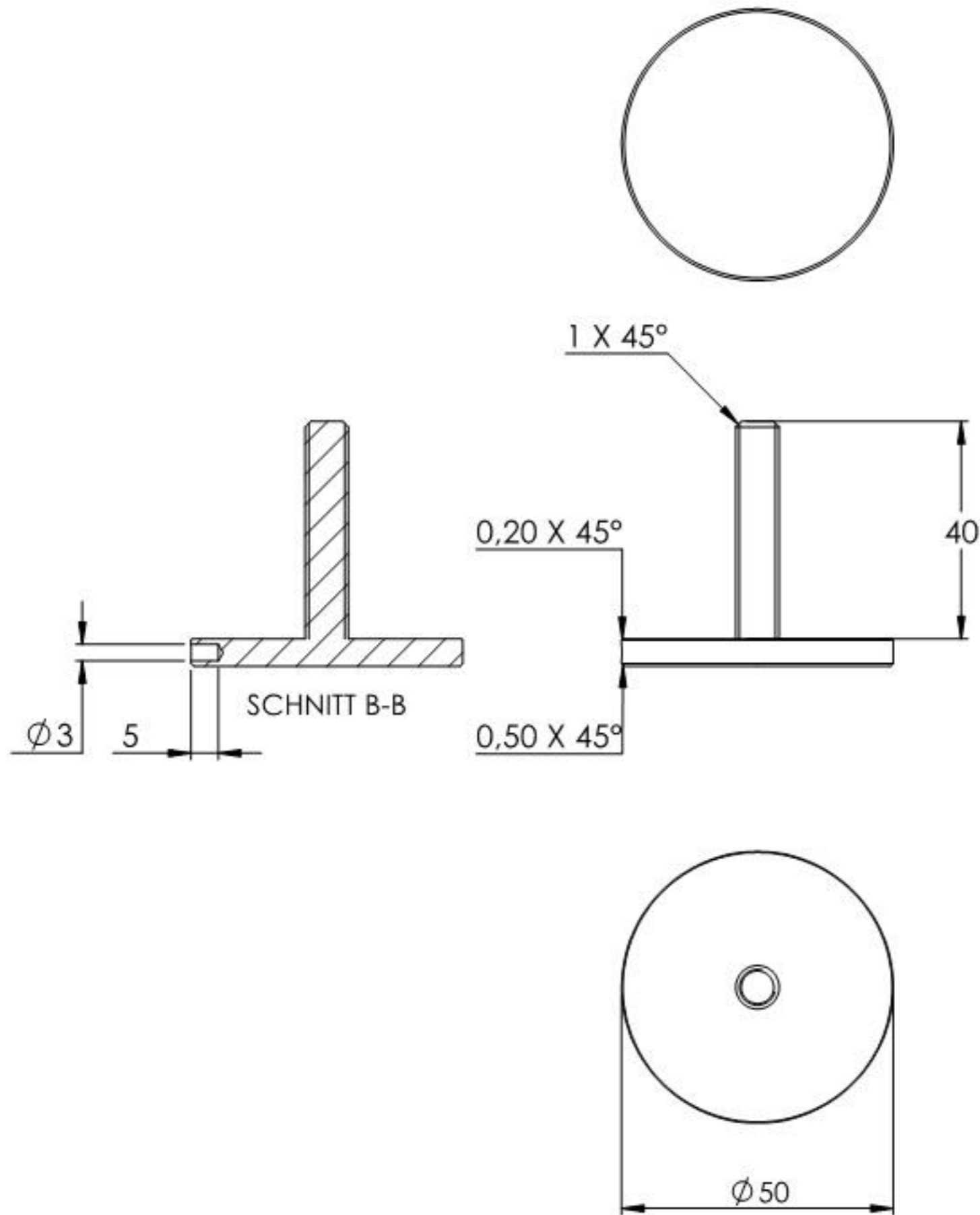

Name	Signatur	Datum	Artikelnummer	Oberfläche: Geschliffen Korn 240
Ch. Höfig	CH	14.12.2020	50352-240 Teil2	
Werkstoff:		Hersteller		Blattformat
1.4301 (X5CrNi18-10)		 <small>EDLSTAHL-ALUMINIUM-SCHWEIßSTEIN</small>		A4
Gewicht 0,093 kg		Maßstab: 1:1,25 Version: 1		Blatt 3 von 8