

Name	Signatur	Datum	Artikelnummer	Oberfläche: Geschliffen Korn 240
Ch. Höfig	CH	14.12.2020	<b>ξ11.2057.4</b>	
Werkstoff:				Blattformat
1.4301 (X5CrNi18-10)				A4
Gewicht 0,464 kg		Maßstab: 1:2	Version: 1	Blatt 1 von 6

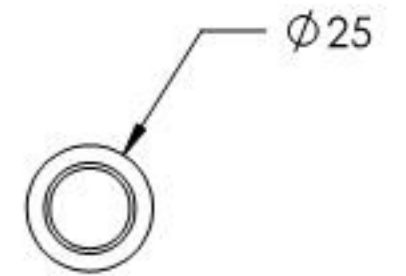

Name	Signatur	Datum	Artikelnummer	Oberfläche: Geschliffen Korn 240
Ch. Höfig	CH	14.12.2020	<b>ξ 11.2057.4</b> il1	
Werkstoff:				Blattformat
1.4301 (X5CrNi18-10)				<b>A4</b>
Gewicht 0.275 kg		Maßstab: 1:2	Version: 1	Blatt 2 von 6

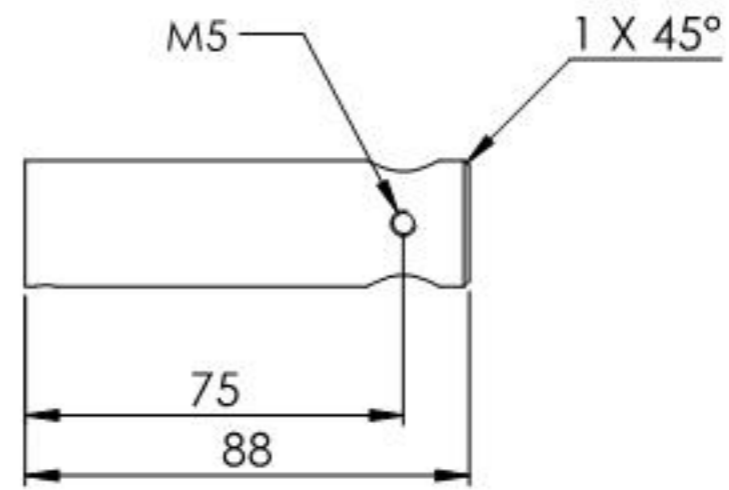
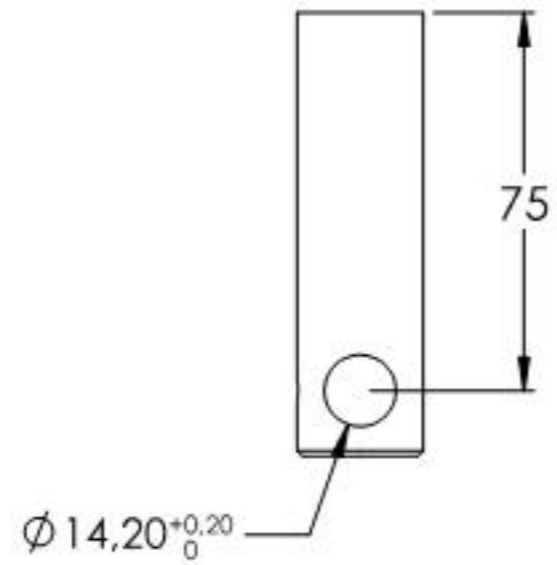
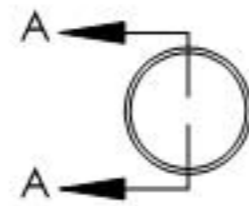
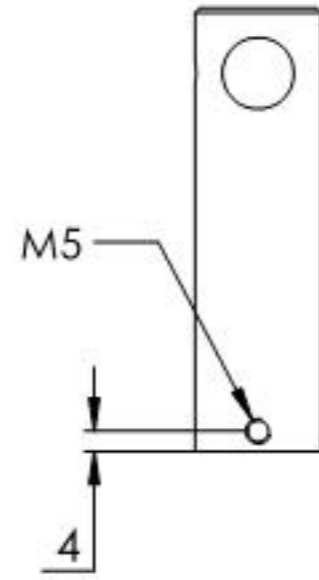
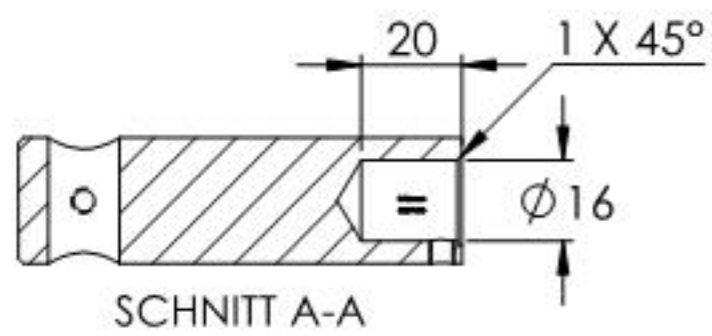
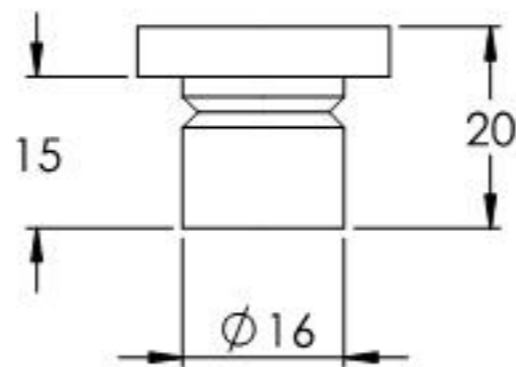
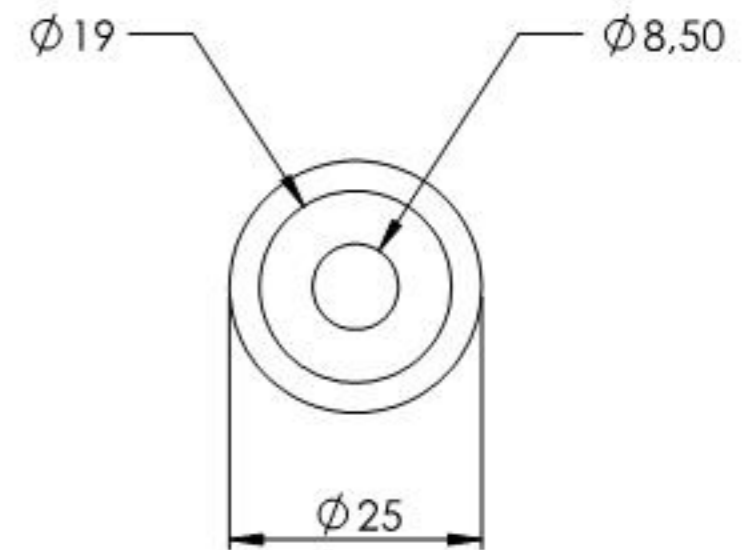
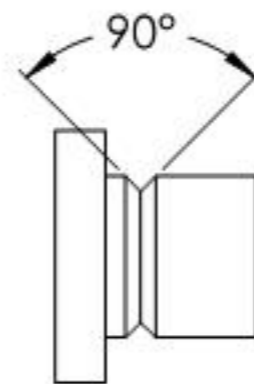
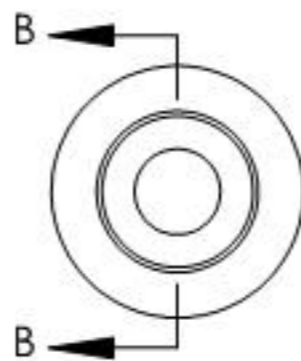
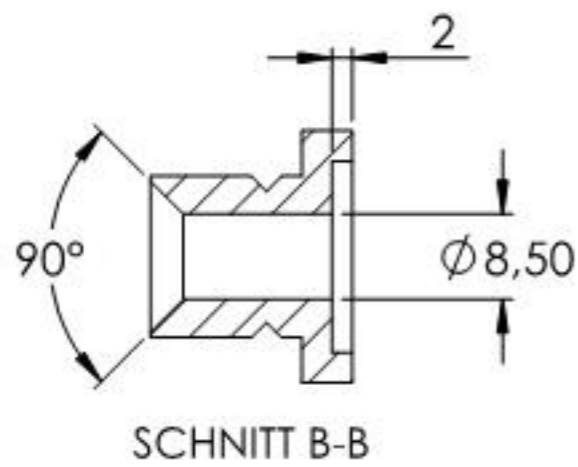
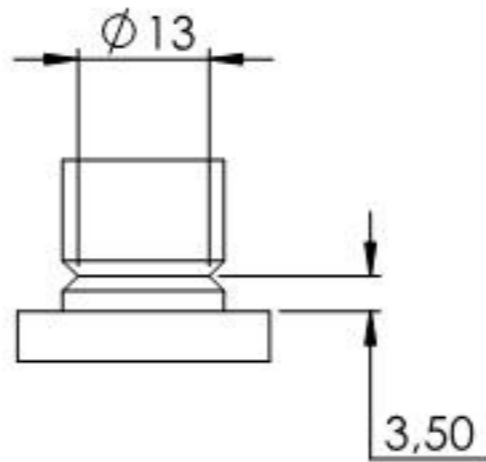

Name	Signatur	Datum	Artikelnummer	Oberfläche: Geschliffen Korn 240
Ch. Höfig	CH	14.12.2020	<b>ξ 11.2057.4il2</b>	
Werkstoff:				Blattformat
1.4301 (X5CrNi18-10)				<b>A4</b>
Gewicht 0,028 kg		Maßstab: 1:1	Version: 1	Blatt 3 von 6