

Name	Signatur	Datum	Artikelnummer	Oberfläche: Geschliffen Korn 240
Ch. Höfig	CH	25.04.2018	(10.5306.4)R	
Werkstoff:				Blattformat
1.4301 (X5CrNi18-10)				A4
Gewicht 0.230 kg		Massstab: 1:1.25	Version: 1	Blatt 1 von 6

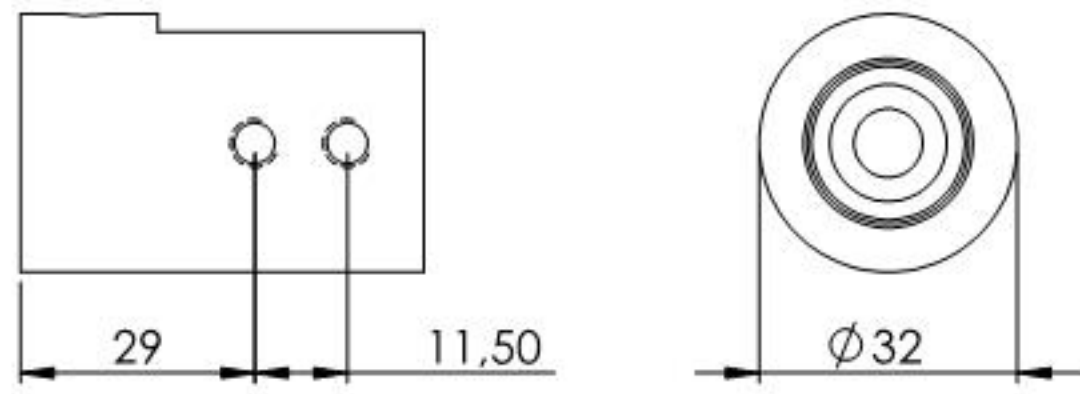

Name	Signatur	Datum	Artikelnummer	Oberfläche: Geschliffen Korn 240
Ch. Höfig	CH	25.04.2018	(10.5306.4)R Teil1	
Werkstoff:				Blattformat
1.4301 (X5CrNi18-10)				A4
Gewicht 0.178 kg		Maßstab: 1:1.25	Version: 1	Blatt 2 von 6

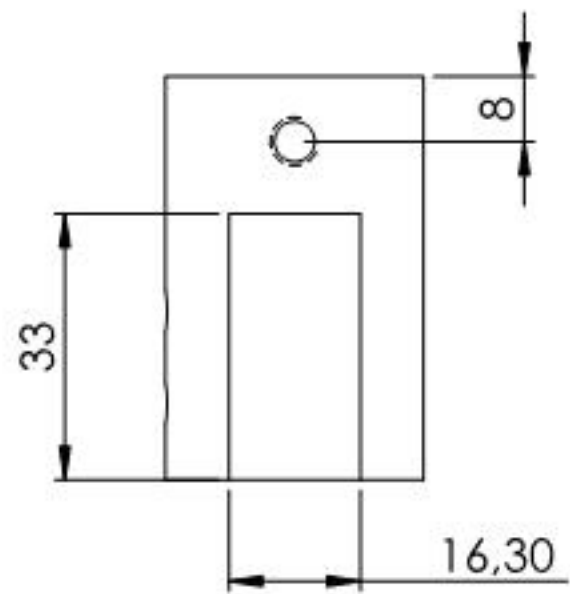
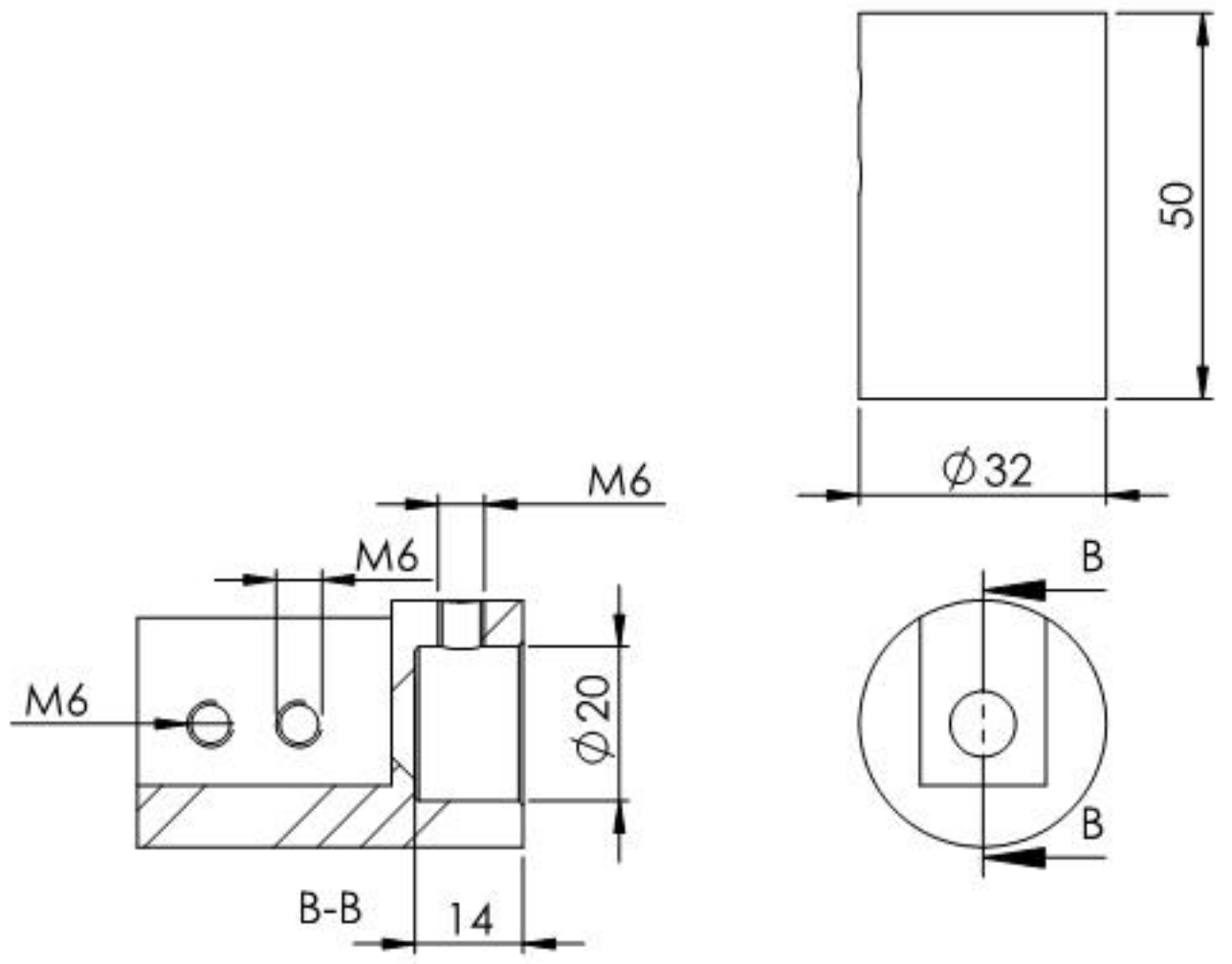
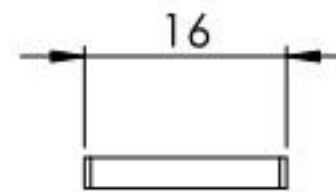
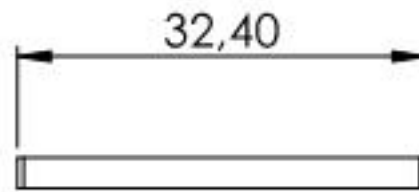
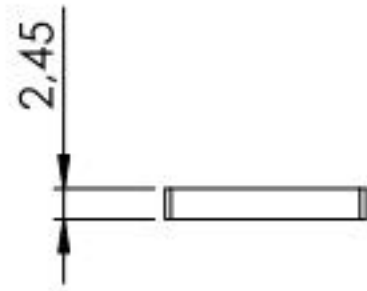

R0,50



Name	Signatur	Datum	Artikelnummer	Oberfläche: Roh
Ch. Höfig	CH	25.04.2018	(10.5306.4)X Teil2	
Werkstoff: EPDM				Blattformat A4
Gewicht 0,001 kg		Massstab: 1,25:1	Version: 1	Blatt 3 von 6