

Name	Signatur	Datum	Artikelnummer	Oberfläche: Roh
Ch. Häfig	CH	03.11.2022	60230-GU	
Werkstoff: EPDM		Hersteller		Blattformat
				A4
Gewicht 0.005 kg		Maßstab: 1.5:1	Version: 1	Blatt 1 von 4

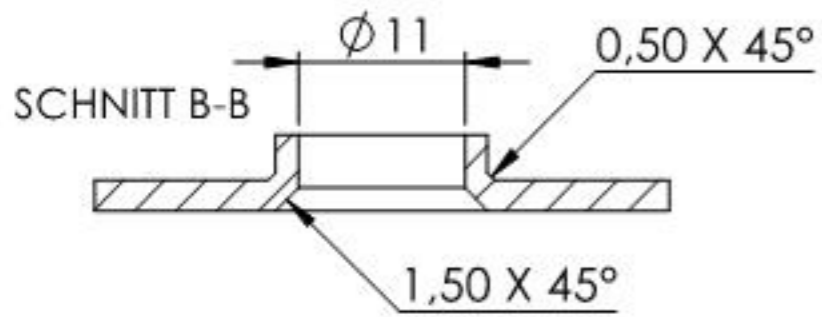

Name	Signatur	Datum	Artikelnummer	Oberfläche: Roh
Ch. Häfig	CH	03.11.2022	60230-GU Teil1	
Werkstoff: EPDM		Hersteller 		Blattformat A4
Gewicht 0.003 kg		Maßstab: 1.5:1	Version: 1	Blatt 2 von 4

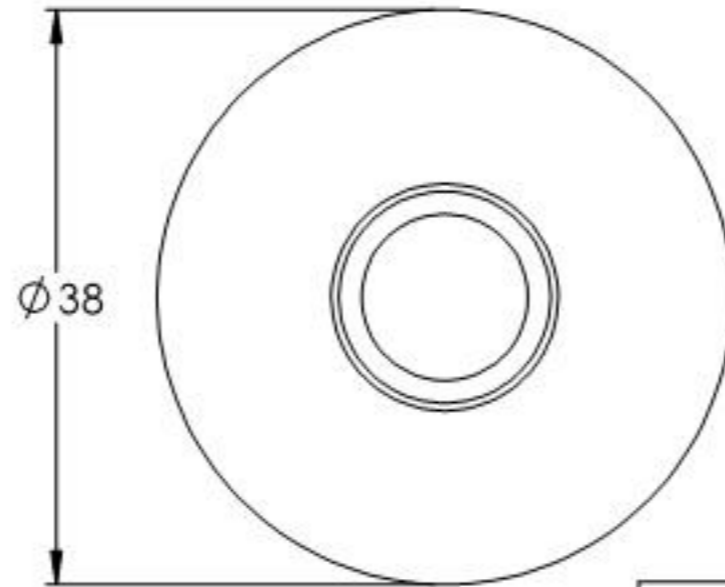
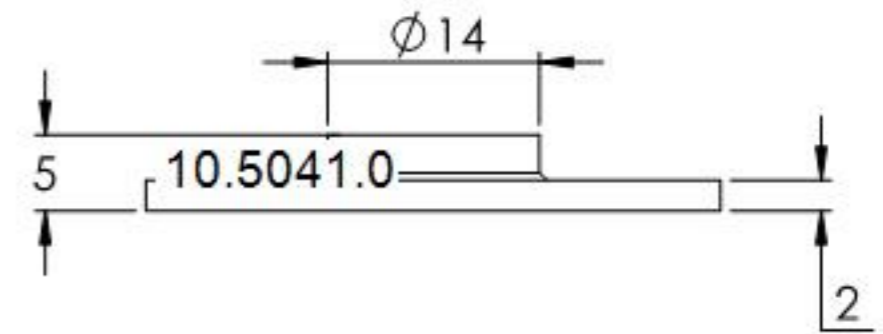
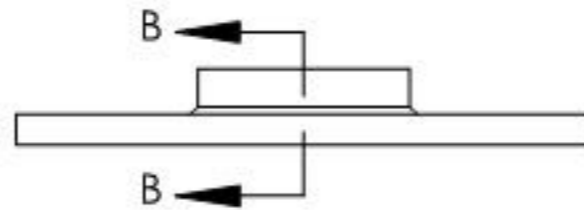
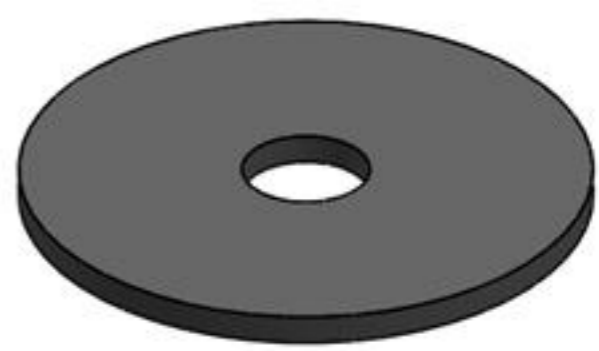
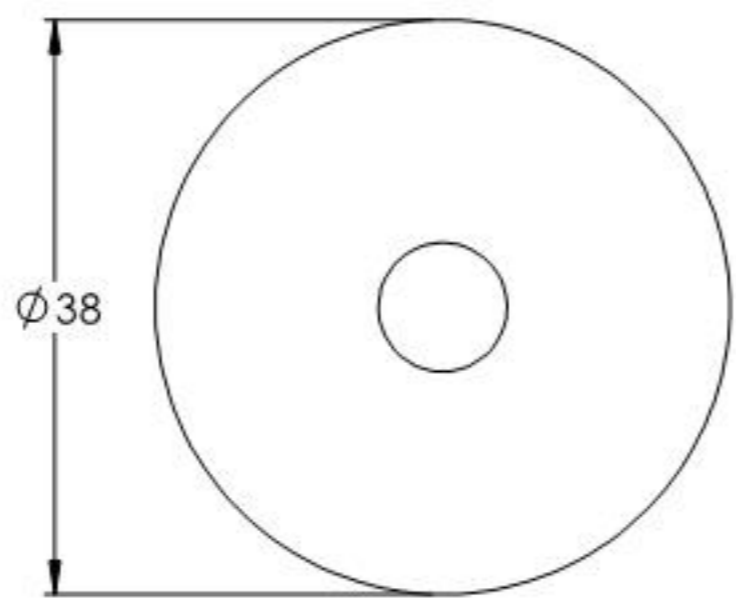
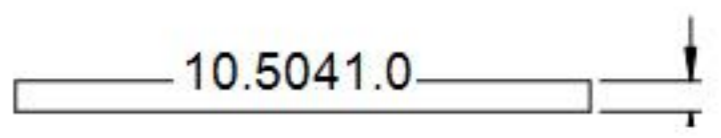
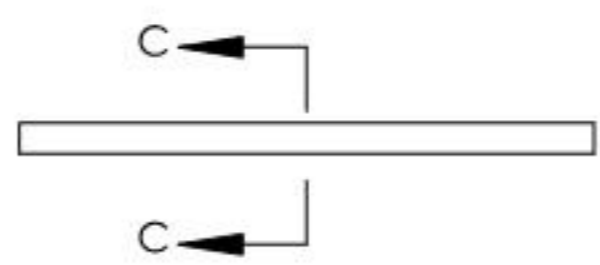
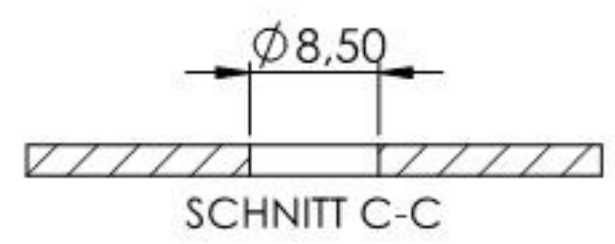

Name	Signatur	Datum	Artikelnummer	Oberfläche: Roh
Ch. Häfig	CH	03.11.2022	60230-GU Teil2	
Werkstoff: EPDM			Hersteller	Blattformat
				A4
Gewicht 0.003 kg			Maßstab: 1.5:1	Version: 1
Blatt 3 von 4				