

M8

SCHNITT B-B

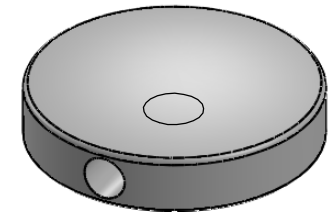

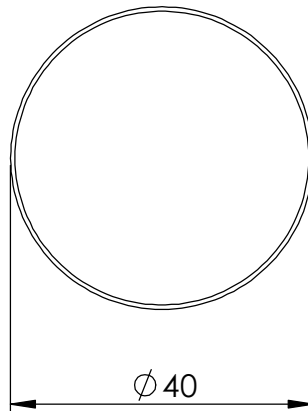
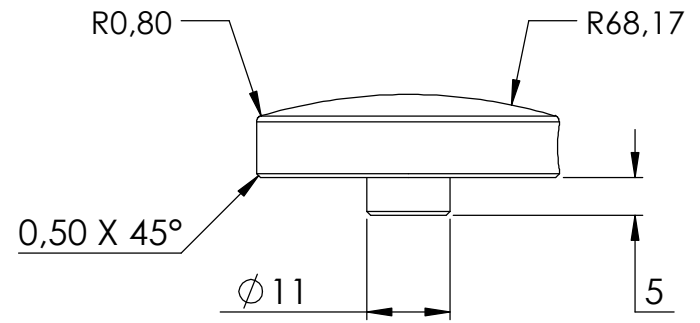
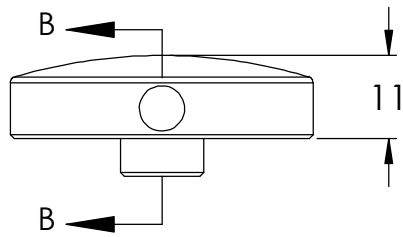
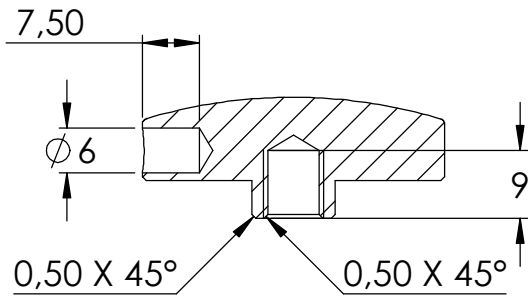
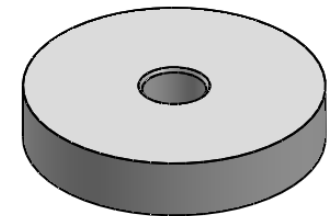
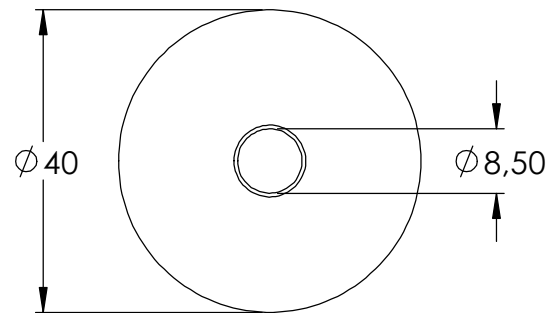
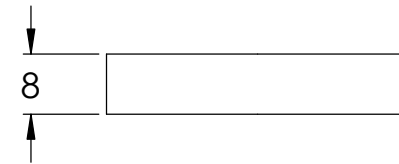
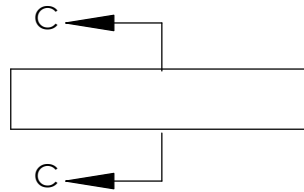
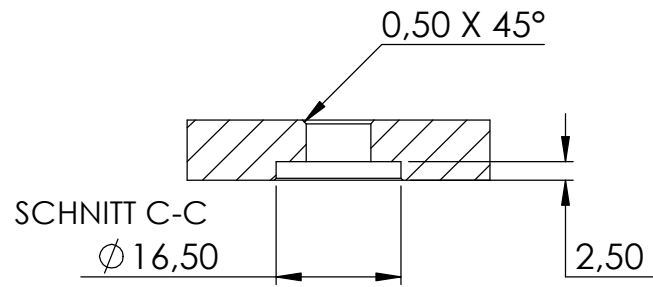
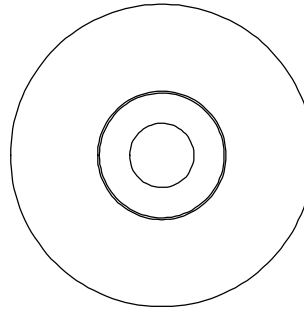

SCHNITT D-D

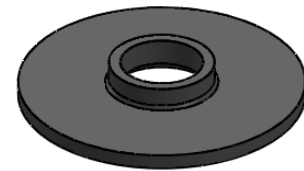
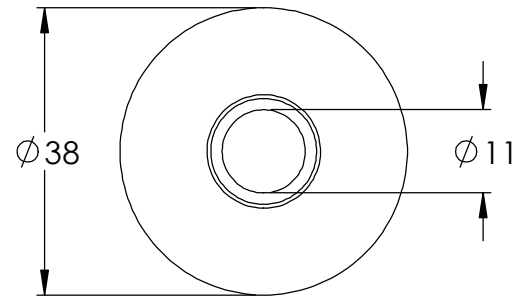
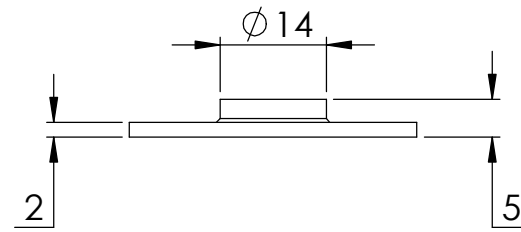
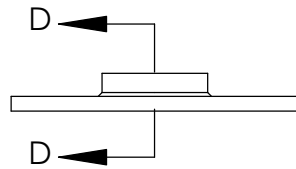
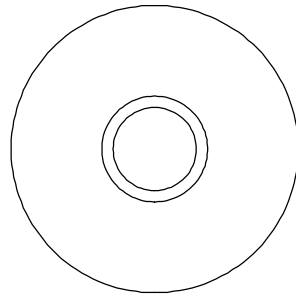
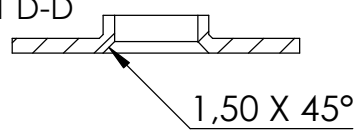

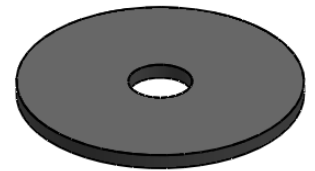
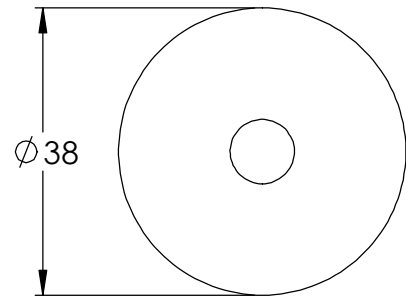
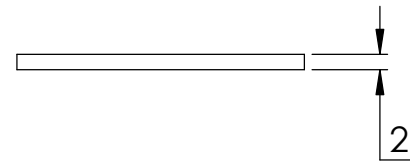
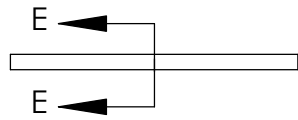
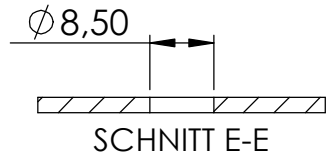
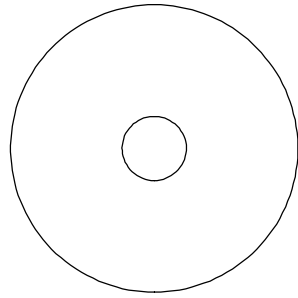

4	DIN 913 M8x45	1
5	6023X-240 Teil4	1

